

# Warmup®

The world's **best-selling** electric floor heating brand™



# 2024 Pricebook



# Here for you

This is your project and we're here to help! Whether it's your first time shopping with Warmup or you are back for more of this life-changing heat, we hope to offer you an unbeatable customer experience.

## Questions?



Call or email us. We want to be accessible when you need us the most.

(888) 592-7687 / [ca@warmup.com](mailto:ca@warmup.com)

24/7 - Online: [www.warmup.ca/warmupedia](http://www.warmup.ca/warmupedia) / [www.youtube.com/user/WarmupInc](http://www.youtube.com/user/WarmupInc)  
or by Phone: (888) 592-7687

## Instant Pricing



You can visit us at [www.warmup.ca](http://www.warmup.ca) for instant pricing. If you prefer to speak with a team member directly, you can call or email us using the contact information listed above.

Upon request, we are happy to supply a layout for your project. A layout shows how to install the product purchased into your space.

## Orders



Orders can be emailed to [ca@warmup.com](mailto:ca@warmup.com) or faxed to (888) 927-4721. We appreciate your understanding that orders must be received in writing.

If it's your first time ordering with Warmup, we'll do our best to get you set up same day and make sure your order is dispatched promptly.

## Returns



Payment is due in full prior to credit approval.

Returns are allowed within 30 days with no penalty. After 30 days, returns are subject to a 20% restocking fee.

## Policies, Simplified



Warranties are industry leading.

For complete general terms, warranty, and shipping information, please see page 3.

# Warmup General Terms & Warranties

## TERMS OF PAYMENT

For orders placed before credit approval, full prepayment is required. Warmup's standard payment terms are net 30 days from the date of the invoice. Special terms and conditions can be arranged through discussions with your Sales Manager. To establish credit, a credit application with signed business terms must be on file with Warmup. Customers opting for advance payment can make payments in advance via credit card. Additionally, include a copy of your Resale Certificate.

## REMIT PAYMENTS

Warmup, Inc  
C/O TH1067  
PO Box 4283  
Postal Station A  
Toronto, ON, M5W 5W6

Shipping and handling will be invoiced based on the products purchased.

## SHIPPING POLICY



## RETURNS

Returns, in resalable condition, are allowed within 30 days of purchase for a full refund. You must request a Return Goods Authorization (RGA) from Warmup. Returns received without an RGA cannot be refunded. After 30 days of purchase, or after expiration of the RGA, Warmup will only issue credit notes on future orders and apply a 20% restocking fee.

## ORDERS

Written orders are required and can be submitted via email at [ca@warmup.com](mailto:ca@warmup.com) or via fax at (888) 927-4721. Orders received before 12:30 PM (Eastern Standard Time) will be shipped on the same or next day via UPS. Orders placed after this deadline will be promptly shipped on the following business day. It is essential to inspect all deliveries for accuracy within 7 days of receipt, as no claims can be accepted thereafter.

## MAP & ONLINE POLICY

Warmup does offer opportunities to sell its products online through third-party resellers or on their websites considering that the authorized dealer agrees to the current MAP policy.

## Warranties

In addition to our traditional warranties, Warmup offers the **The SafetyNet™ Guarantee** to all installers. Receive a free and immediate replacement for product damaged during the installation process. Because 99% of issues happen during installation and not thereafter, Warmup wants to ensure that the system installed is free and clear of any defects or damage.

For detailed Warranty and SafetyNet™ terms, visit [www.warmup.ca/about/best-warranties](http://www.warmup.ca/about/best-warranties).

DCM Cable, DCM Membrane, & DWM StickyMat	FOIL, WODH In-Slab, SR Freeze Protection, and WSM & WSMM Snow Melting	6iE Thermostat & Terra Thermostat*	SNOPRO Series, DS Series Towel Warmers, RFT Thermostat, & WUDG-4999 Thermostat	CommBox, ResiBox, AirSense & WRGH Cable De-Icing

\*When installed with a Warmup heater

We carry multiple approvals across our product range. For all our approvals, visit [www.warmup.com](http://www.warmup.com)





# DCM-PRO Cable

Warmup DCM-PRO Cable is designed to fit the Warmup DCM-PRO Membrane. The cable can be spaced at various intervals for the highest flexibility in heat outputs, from Comfort Heating to Primary Heating.\* For better results, pair with a Warmup Thermostat for lowest consumption cost when installed with 1/4" Warmup Ultralight™ 4-in-1 Insulation Boards.

\*heat loss calculations will be needed to make sure primary heating can be accomplished.

## Quote in 5 Easy Steps:

1. Cable
2. Membrane OR Fixing Strips
3. Accessories
4. Thermostat
5. Optional Insulation

Thickness	3/16" (4.5mm +/- 0.2mm)
Output	Varies with spacing from 10W/sqft to 16W/sqft
Construction	Multi-stranded, dual wire
Inner Insulation	ETFE
Outer Jacket	PVC
Ground Braid	85% min copper
Cold Lead	10ft (3m) long, 2 core braided

The DCM-PRO System is warranted for 30 years when paired with a Warmup Thermostat, the DCM-PRO Membrane and the DCM-PRO Cable. For full warranty details, see [www.warmup.com/about/best-warranties](http://www.warmup.com/about/best-warranties)

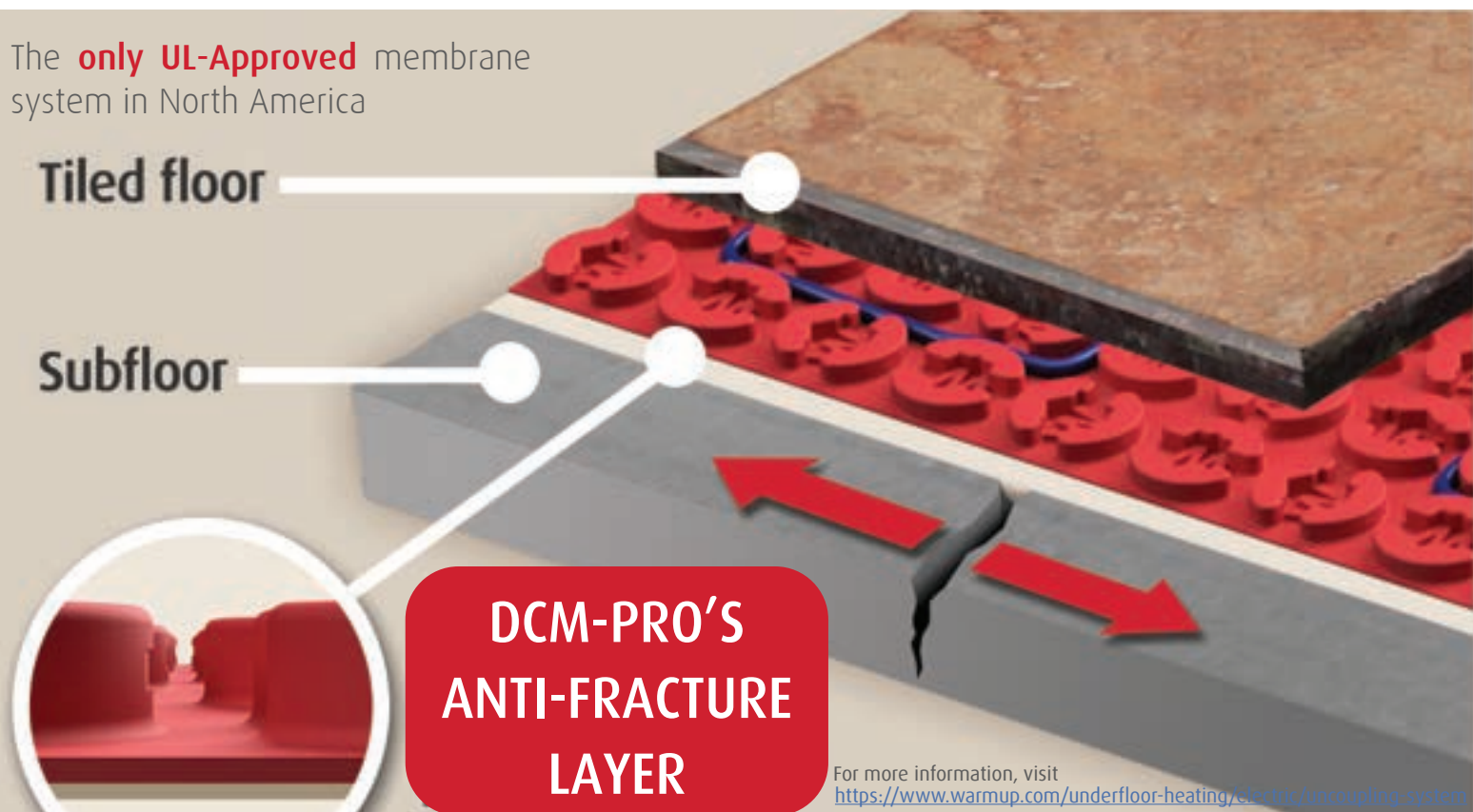

	PRODUCT CODE	Cable length (ft)	Amps	Resistance (Ω)	Square Foot Coverage with Membrane				Square Foot Coverage Loose Lay		Canada
					2-3 pegs	3 pegs	3-4 pegs	4 pegs	3"	4"	
120 Volt	DCM-120-65	16.7	0.5	221.5	4	5	6	7	4	6	\$182.00
	DCM-120-130	33.1	1.1	110.8	8	10	12	13	8	11	\$213.00
	DCM-120-195	49.9	1.6	73.8	13	15	18	20	12	17	\$258.00
	DCM-120-260	66.3	2.2	55.4	17	20	23	27	17	22	\$295.00
	DCM-120-325	83.0	2.7	44.3	21	25	29	33	21	28	\$332.00
	DCM-120-390	99.4	3.3	36.9	25	30	35	40	25	33	\$363.00
	DCM-120-525	132.9	4.4	27.4	33	40	47	53	33	44	\$436.00
	DCM-120-655	166.0	5.5	22.0	42	50	58	67	42	55	\$486.00
	DCM-120-785	199.1	6.5	18.3	50	60	70	80	50	66	\$536.00
	DCM-120-920	232.3	7.7	15.6	58	70	82	93	58	77	\$586.00
	DCM-120-1050	265.4	8.8	13.7	67	80	93	107	66	88	\$647.00
	DCM-120-1180	298.6	9.8	12.2	75	90	105	120	75	100	\$713.00
	DCM-120-1315	331.7	11.0	11.0	83	100	117	133	83	111	\$776.00
	DCM-120-1445	364.8	12.0	10.0	91	110	128	147	91	122	\$842.00
	DCM-120-1575	398.0	13.1	9.1	100	120	140	160	99	133	\$901.00
240 Volt	DCM-240-195	50.0	0.8	296.0	13	15	18	20	12	17	\$253.00
	DCM-240-325	83.0	1.4	177.2	21	25	29	33	21	38	\$332.00
	DCM-240-390	99.4	1.6	147.7	25	30	35	40	25	33	\$362.00
	DCM-240-525	132.9	2.2	109.7	33	40	47	53	33	44	\$435.00
	DCM-240-655	166.0	2.8	87.9	42	50	58	67	42	55	\$487.00
	DCM-240-785	199.1	3.3	73.4	50	60	70	80	50	66	\$536.00
	DCM-240-920	232.3	3.9	62.6	58	70	82	93	58	77	\$585.00
	DCM-240-1050	265.4	4.5	54.9	67	80	93	107	66	88	\$647.00
	DCM-240-1180	298.6	5.0	48.8	75	90	105	120	75	100	\$692.00
	DCM-240-1310	331.7	5.6	44.0	83	100	117	133	83	111	\$729.00
	DCM-240-1640	414.7	7.0	35.1	104	125	146	167	104	138	\$806.00
	DCM-240-1970	497.7	8.4	29.2	125	150	175	200	124	166	\$941.00
	DCM-240-2300	580.7	9.8	25.0	146	175	204	233	145	194	\$1,089.00
	DCM-240-2630	663.4	11.2	21.9	166	200	233	266	166	221	\$1,130.00
	DCM-240-2955	746.4	12.6	19.5	187	224	262	300	187	249	\$1,209.00
DCM-240-3240	829.4	13.5	17.8	208	249	292	333	207	276	\$1,345.00	

\*For 208V figures, see product specification sheet, which can be found on [www.warmup.com](http://www.warmup.com) or [www.warmup.ca](http://www.warmup.ca)

## APPLICATION - MEMBRANE OR FIXING BAND

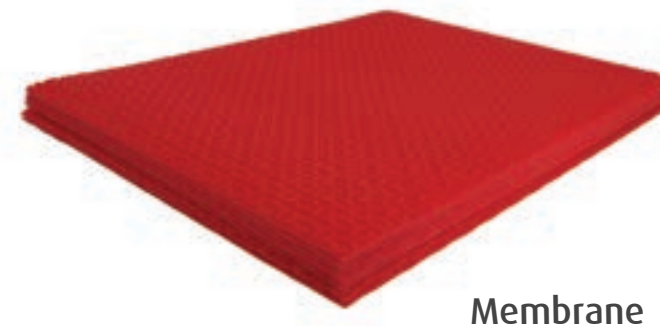

# DCM-PRO Uncoupling Membrane

## Peel-and-Stick or Fleece-Backed

The TCNA-tested DCM-PRO Anti-Fracture Membrane is available in Peel-and-Stick or Fleece-Backed and can be installed on wood and cement subfloors using any tile adhesive. The patented DCM-PRO design allows for more cable to adhesive contact, ultimately distributing heat more evenly. There is minimal waiting required after installation, so you can begin laying the flooring immediately.

### Application

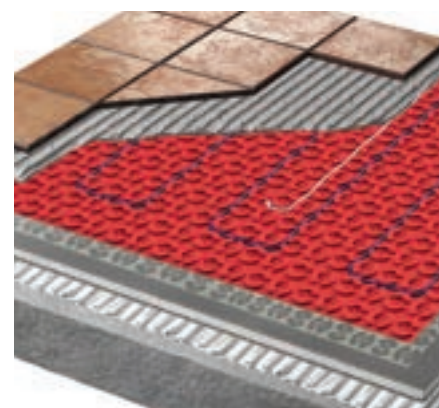

#### Peel-and-Stick

Installs in minutes with self-adhesive backing.

- Reduces project time by 24 hours, enabling immediate cable installation
- 40% savings on labor and material
- Ideal for clean and smooth floors
- Best for remodels and multi-units
- Doesn't roll back: no memory
- A great thinset-to-cable contact for a better heat distribution
- Watch our [DCM-PRO Peel-and-Stick](#) Installation video

**NO  
THINSET  
REQUIRED  
BELOW**

Code	Description	Dimensions of each sheet/roll	Canada
DCM-PSW-70	Box of 10 Peel-and-Stick sheets, covering 71.8 sqft in total.	3'3" x 2'3"	\$266.00
DCM-PSW-150	Roll of Peel-and-Stick membrane, covering 150 sqft in total.	3'3" x 47'2"	\$486.00

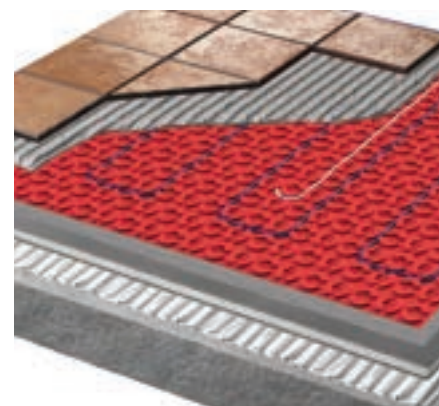

#### Fleece-Backed

Use with any tile adhesive above and below.

- Suitable for all types of flooring
- Enhances heat distribution due to the castellation feature
- Ideal for rough and uneven subfloors
- Tile in one hour
- Cover with self-levelers for versatile floor finishes
- Watch our [DCM-PRO Fleece-Back](#) Installation video

Code	Description	Dimensions of each sheet/roll	Canada
DCM-MW-70	Box of 10 Fleece-backed sheets, covering 71.8 sqft in total.	3'3" x 2'3"	\$239.00
DCM-MW-150	Roll of Fleece-backed membrane, covering 150 sqft in total.	3'3" x 47'2"	\$473.00

Code	Accessories	Canada
ACC-DGMTR	The Alligator Tester - Digital Multimeter.	\$30.00
DCM-SP-10K	Additional Floor Sensor.	\$27.00
RL-120V25A	General purpose 25A/120V relay used to expand the switching capability of the Warmup Thermostats. Mounts in single gang box.	\$110.00
RL-240V25A	General purpose 25A/240V relay used to expand the switching capability of the Warmup Thermostats. Mounts in single gang box.	\$114.00
DCM-FB-82	Metal Fixing Band - 82' long spool.	\$136.00
ACC-PLTL	Heavy Duty Plastic Trowel 11" x 5.5" with 1/4" U-notch design.	\$19.00
RK-INDOOR	Indoor Heating Cable Repair Kit.	\$16.00
RK-ENDCAP	Indoor Heating Cable End Cap Repair Kit.	\$12.00
RK-JOINT	Indoor Heating Cable factory Joint Repair Kit (Cold Lead/Tail Splice).	\$12.00
ACC-00WATCHDOG	The Watch Dog Tester - Sounds an alarm when connected to a broken heating cable.	\$25.00
DCT-SBOX	The Dual Cable Tester - Can test two load-neutral-ground connections of heating cables at once.	\$60.00

Code	Thermostats	Canada
6iE-04-CW-LC	Warmup's most popular thermostat, the white WiFi 6iE® featuring a smartphone quality touchscreen.	\$320.00
TRA-04-WH-LC	Warmup Terra Smart WiFi Thermostat with a minimal display for a contemporary look.	\$307.00
RFT-P-WH	Warmup's basic, programable thermostat with touch buttons and probe.	\$199.00

Code	Optional Insulation	Canada
WCI-1	Warmup Ultralight Underfloor Heating Boards, 3'3x 2'3 x 1/4" (985mm x 678mm x 6mm) Single Board. (order of 5 minimum).	\$37.72
WCI-10	A box of 10 Warmup Ultralight Underfloor Heating Boards, 3'3x 2'3 x 1/4" (985mm x 678mm x 6mm).Covering 71.8sqft.	\$377.21

## Waterproofing

Code	Waterproofing Accessories	Canada
DCM-WP-B35	Waterproofing for DCM-PRO. Includes a 35ft roll of tape.	\$56.00
DCM-WP-IN	Waterproofing for DCM-PRO. Includes 2 inside corners.	\$24.00
DCM-WP-OUT	Waterproofing for DCM-PRO. Includes 2 outside corners.	\$24.00

Roll	35' x 5"
Inside Corner (2/kit)	115mm x 115mm
Outside Corner (2/kit)	105mm x 105mm





# DCM-PRO Project Examples



SCAN FOR INSTANT PRICING

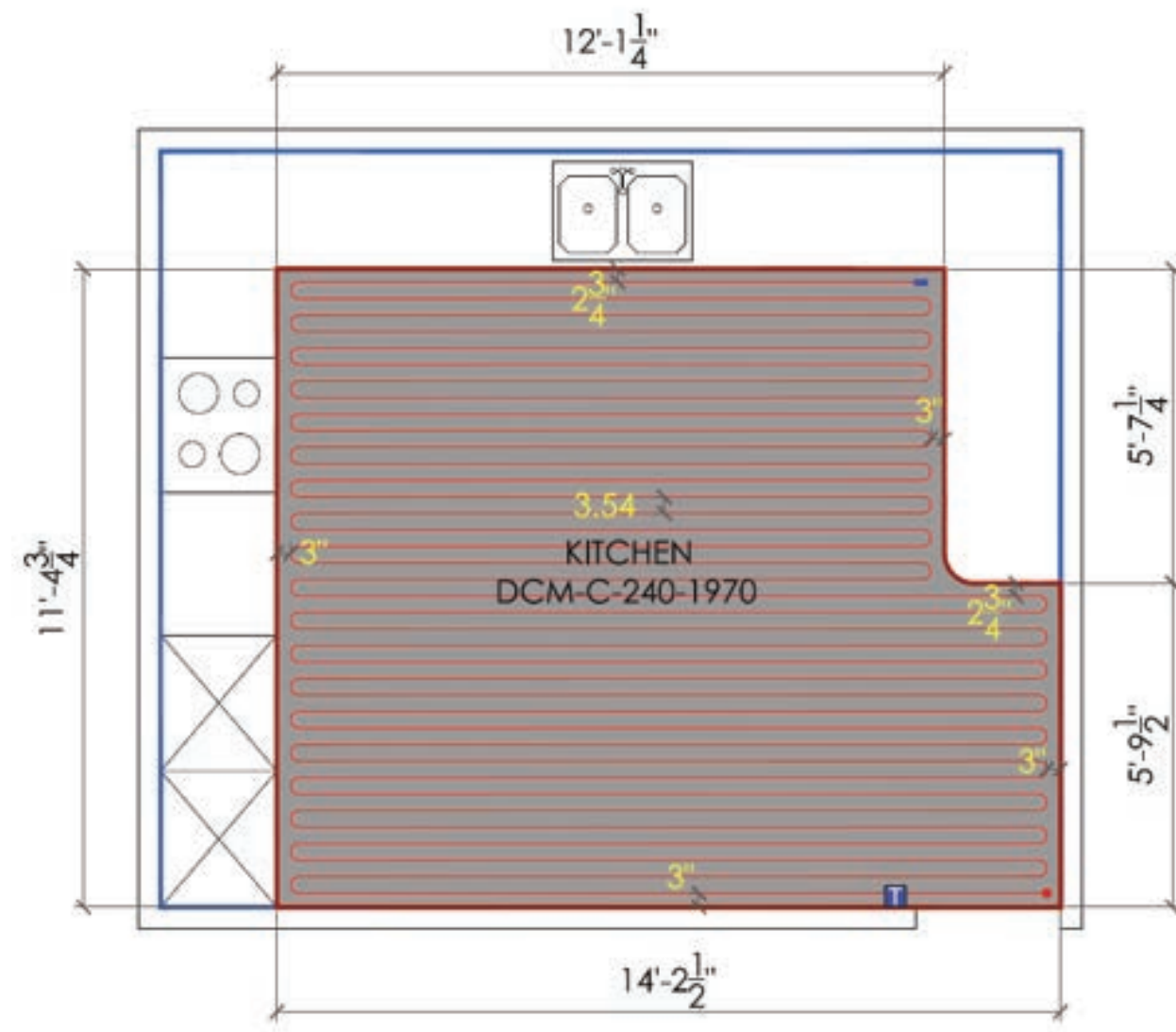
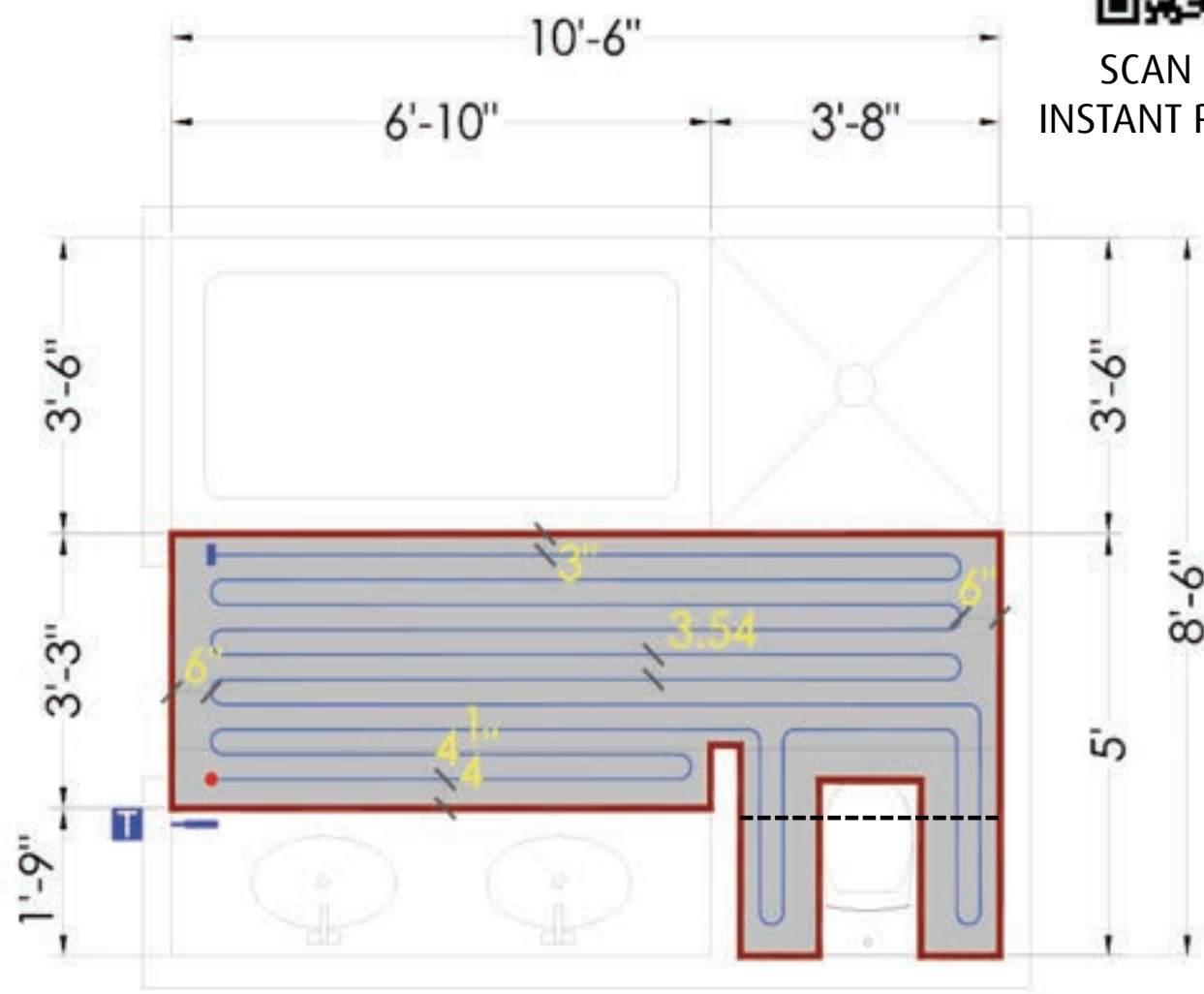

Size 89 sq. ft.		Cost \$922.00	Type DCM-PRO	
Total Room Area	89 Sqft		<b>Specifications</b>	
Surface to be Heated	35 Sqft		Voltage	120
Heating System	DCM-C-120-390	\$363.00	Amps	3.30
Membrane	DCM-MW-70	\$239.00	Total BTU Equivalent	1,330
Thermostat	6iE-04-CW-LC	\$320.00		
	Subtotal	\$922.00		

Size 237 sq. ft.		Cost \$1,747.00	Type DCM-PRO	
Total Room Area	237 Sqft		<b>Specifications</b>	
Surface to be Heated	150 Sqft		Voltage	240
Heating System	DCM-C-240-1970	\$941.00	Amps	8.21
Membrane	DCM-PSW-150	\$486.00	Total BTU Equivalent	6,723
Thermostat	6iE-04-CW-LC	\$320.00		
		\$1,747.00		

# StickyMat™

Use under tile, stone, & LVT

The Warmup StickyMat is designed for use within an adhesive layer under tiles or within a leveling compound under other floor finishes. The fixed spacing and self-adhesive mat makes installation of regularly shaped rooms quick and easy, whilst ensuring precision is maintained.

## Quote in 4 Easy Steps:

1. Heating Mat
2. Accessories
3. Thermostat
4. Optional Insulation

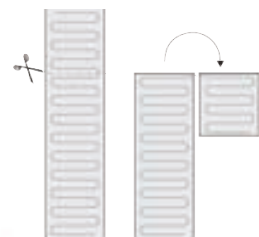

Close-up of the pressure-sensitive adhesive

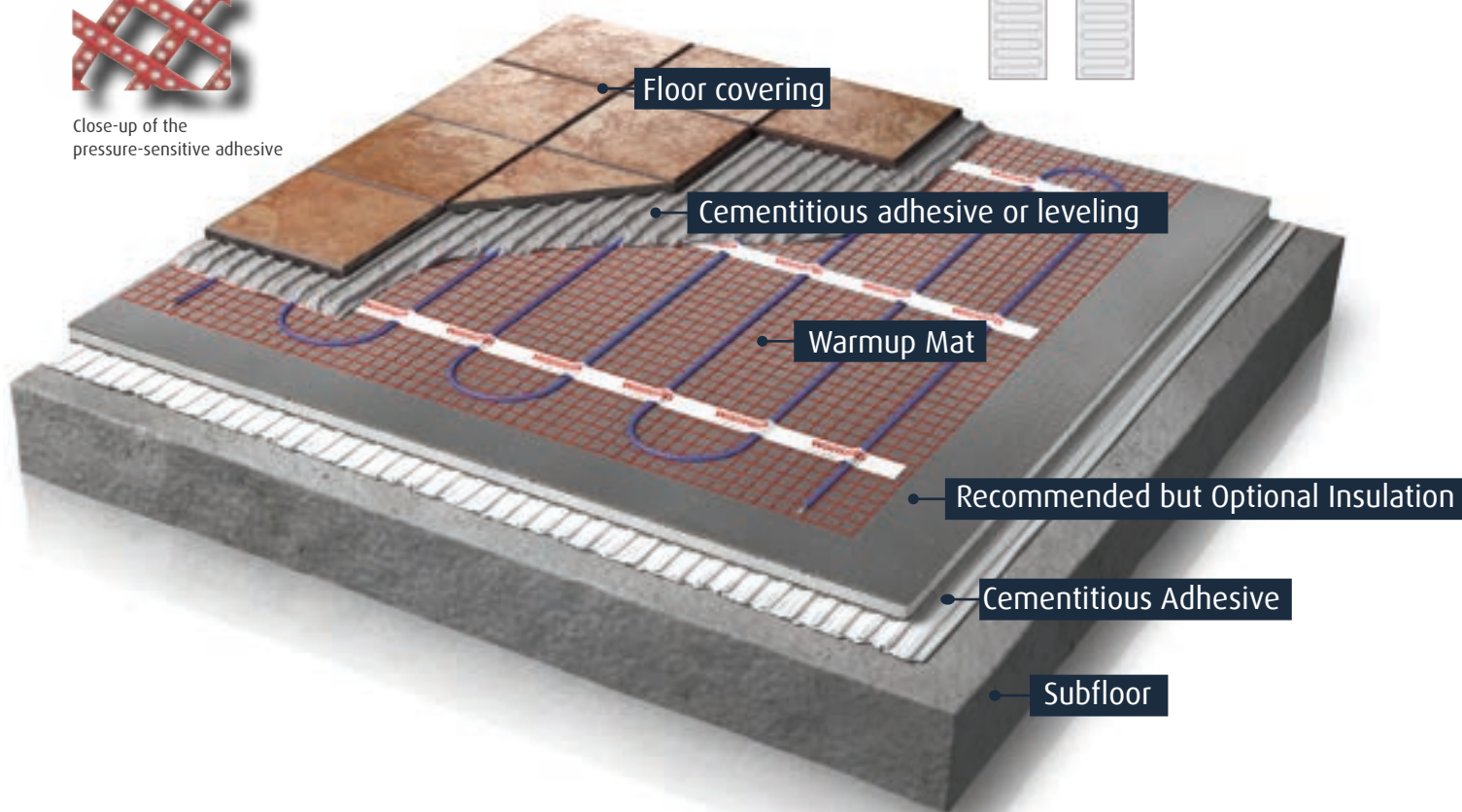

	Area (sqft)	Code	Mat Length (ft) (20" wide)	Cable Length (ft)	Wattage	Amps	Resistance (Ω)	Canada	
120V	10	DWM-120-140	6'	40'	140	1.16	102.8	\$278.00	
	15	DWM-120-210	9'	60'	210	1.75	68.5	\$338.00	
	20	DWM-120-280	12'	80'	280	2.33	51.4	\$399.00	
	25	DWM-120-350	15'	100'	350	2.91	41.2	\$463.00	
	30	DWM-120-420	18'	120'	420	3.49	34.3	\$511.00	
	40	DWM-120-560	24'	160'	560	4.66	25.7	\$608.00	
	50	DWM-120-700	30'	200'	700	5.82	20.6	\$734.00	
	60	DWM-120-840	37'	240'	840	7.01	17.1	\$849.00	
	75	DWM-120-1050	46'	300'	1050	8.75	13.7	\$1,044.00	
	90	DWM-120-1260	55'	360'	1260	10.52	11.4	\$1,210.00	
	110	DWM-120-1540	67'	440'	1540	12.76	9.4	\$1,421.00	
	120	DWM-120-1620	73'	480'	1620	13.48	8.9	\$1,499.00	
240V	25	DWM-240-350	15'	100'	350	1.45	164.6	\$462.00	
	40	DWM-240-560	24'	160'	560	2.33	102.9	\$608.00	
	50	DWM-240-700	30'	200'	700	2.91	82.3	\$734.00	
	75	DWM-240-1050	46'	300'	1050	4.37	54.9	\$1,033.00	
	90	DWM-240-1260	55'	360'	1260	5.25	45.7	\$1,210.00	
	110	DWM-240-1540	67'	440'	1540	6.41	37.4	\$1,451.00	
	150	DWM-240-2100	91'	600'	2100	8.75	27.4	\$1,834.00	
	180	DWM-240-2520	110'	720'	2520	10.48	22.9	\$2,148.00	
	220	DWM-240-3080	134'	880'	3080	12.83	18.7	\$2,519.00	
	240	DWM-240-3240	146'	960'	3240	13.48	17.8	\$2,674.00	
	120V - 3ft Wide	9	DWM-09-120	3 x 3	31.8'	126	1.05	114.3	\$269.00
		15	DWM-15-120	3 x 5	60'	210	1.75	68.5	\$338.00
18		DWM-18-120	3 x 6	63.6'	252	2.10	57.1	\$391.00	
24		DWM-24-120	3 x 8	86.8'	336	2.80	42.9	\$463.00	
30		DWM-30-120	3 x 10	120'	420	3.50	34.3	\$511.00	

\*For 208V figures, see product specification sheet, which can be found on [www.warmup.com](http://www.warmup.com) or [www.warmup.ca](http://www.warmup.ca)

Code	Accessories	Canada
ACC-DGMTR	The Alligator Tester - Digital Multimeter.	\$30.00
DCM-SP-10K	Additional Floor Sensor.	\$27.00
RL-240V25A	General purpose 25A/240V relay used to expand the switching capability of the Warmup thermostats. Mounts in single gang box.	\$114.00

Code	Thermostats	Canada
6iE-04-CW-LC	Warmup's most popular thermostat, the white WiFi 6iE® featuring a smartphone quality touch-screen.	\$320.00
TRA-04-WH-LC	Warmup Terra Smart WiFi Thermostat with a minimal display for a contemporary look.	\$307.00
RFT-P-WH	Warmup's basic, programable thermostat with touch buttons and probe.	\$159.00



# StickyMat™ Project Examples



SCAN FOR INSTANT PRICING

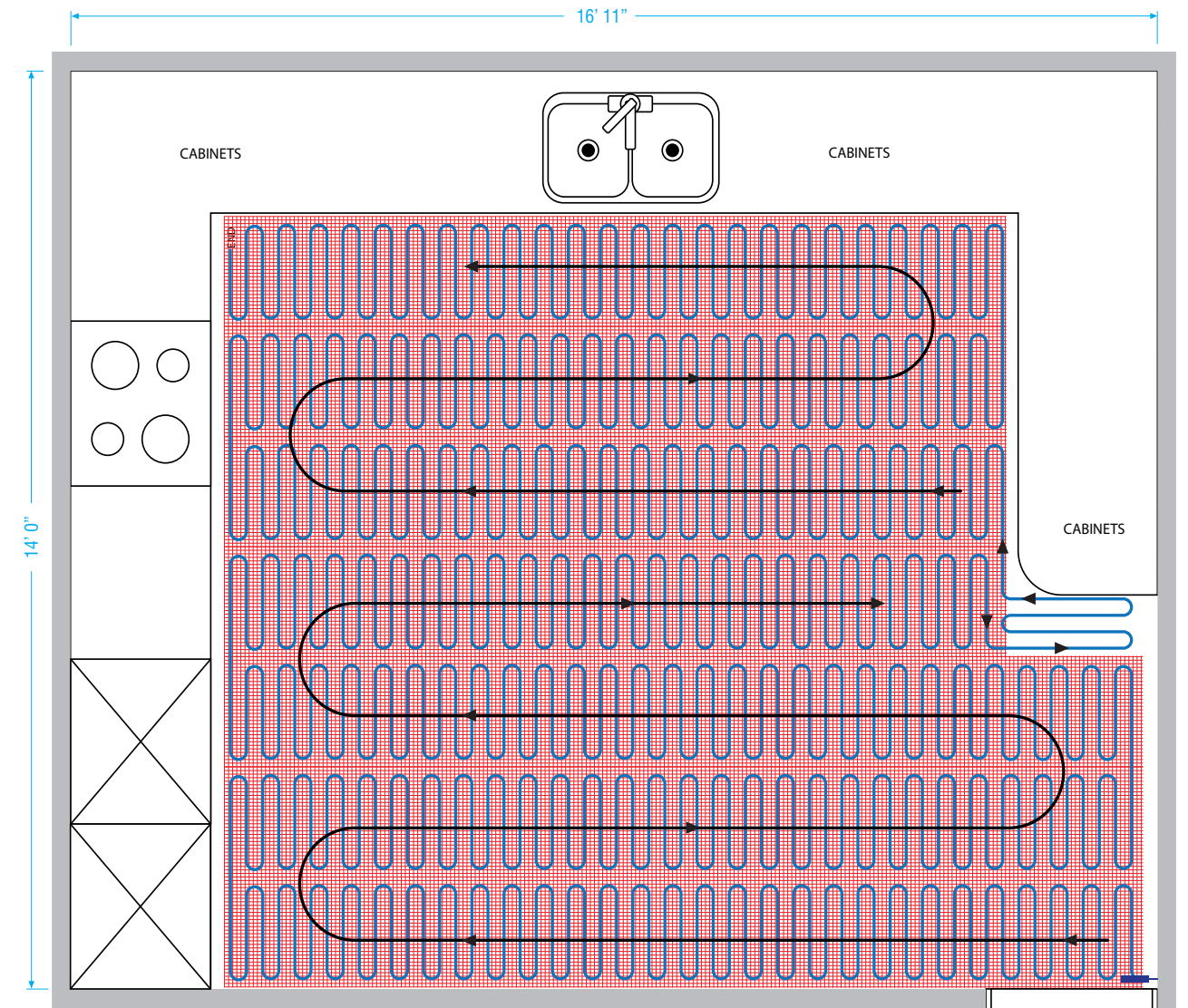
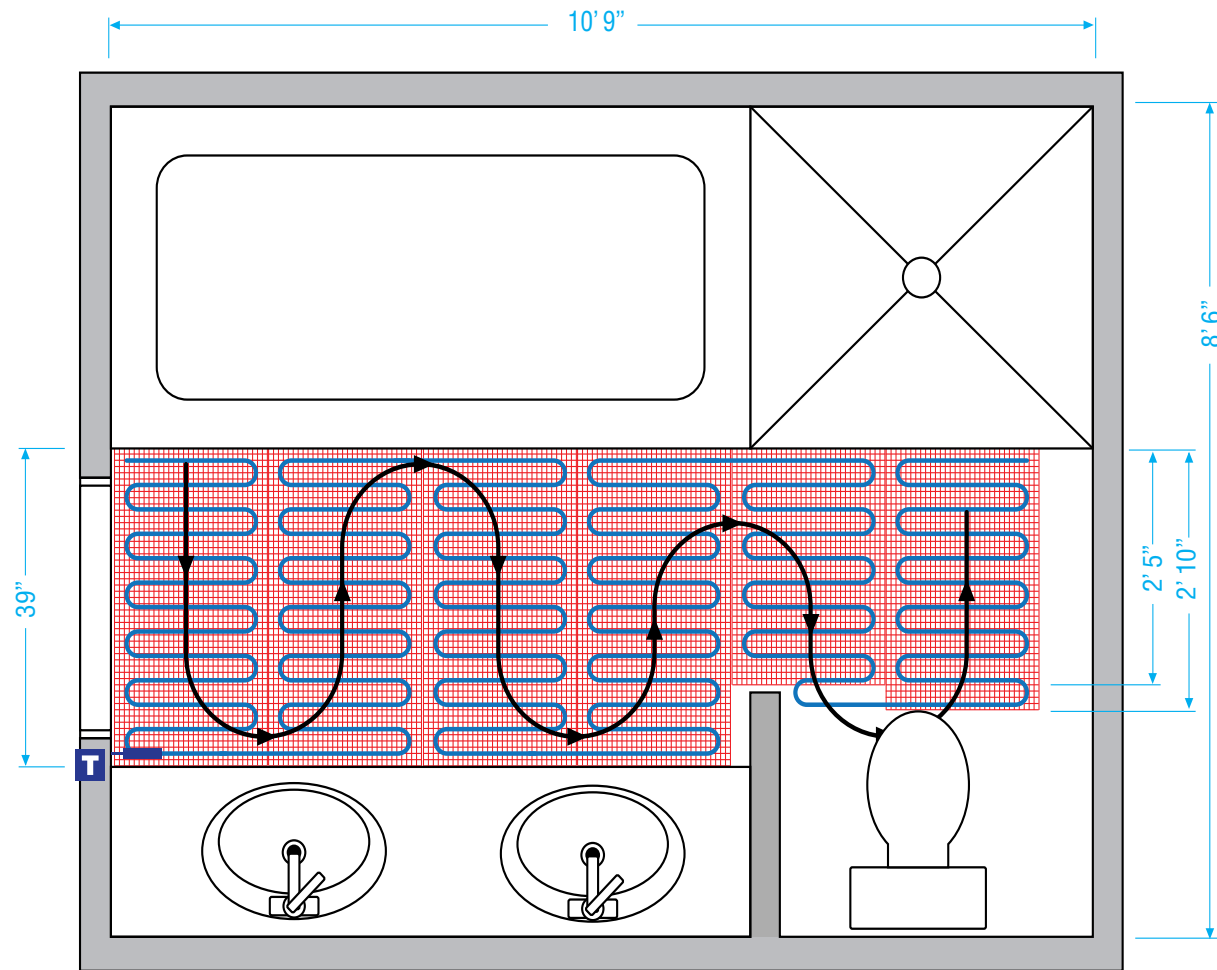

Size		Cost		Type	
<b>89 sq. ft.</b>		<b>\$831.00</b>		<b>StickyMat™</b>	
Total Room Area	89 Sqft			<b>Specifications</b>	
Surface to be Heated	35 Sqft			Voltage	120
Heating System	DWM-120-420 Floor Heating Mat	\$511.00		Amps	3.5
Thermostat	6iE Thermostat	\$320.00		Total BTU Equivalent	1,433
		Subtotal	\$831.00		

Size		Cost		Type	
<b>237 sq. ft.</b>		<b>\$2,154.00</b>		<b>StickyMat™</b>	
Total Room Area	237 Sqft			<b>Specifications</b>	
Surface to be Heated	160 Sqft			Voltage	240
Heating System	DWM 240-2100 Floor Heating Mat	\$1,834.00		Amps	8.8
Thermostat	6iE Thermostat	\$320.00		Total BTU Equivalent	7,165
		Subtotal	\$2,154.00		

# FOIL System

For use under Carpet, Laminate, & Floating Engineered Wood Floors

The Warmup FOIL system is an electric mat for floating floors that **requires no mortar**. The system can be customized for installation in regularly shaped spaces. The FOIL product is designed to be installed between underlay and the finished flooring. All tested carpet pads are sufficient underlay.

For laminate and wood installations, Warmup requires the use of Insulated Underlay or 4-in-1 Ultralight Insulation Boards to provide better heat outputs and faster heat-up times. For a higher efficient system, use the Ultralight Insulation Boards. The Ultralight Insulation Boards are a 4-in-1 specialized composite board designed for floor heating applications. The boards sit between the cold subfloor and the Warmup FOIL Heating System, preventing heat loss, making the underfloor heating system more efficient and effective. The Foil backing acts as an effective moisture barrier.

## Quote in 4 Easy Steps:

1. FOIL Heater
2. Accessories
3. Thermostat
4. Ultralight Insulation Boards/  
Warmup Insulated Underlay

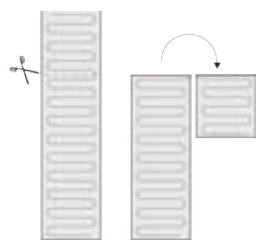

Area (sqft)	Code	Mat length (20" wide)	Wattage	Amps	Resistance (Ω)	Canada
20	FOIL-20-240	12'	240	1.00	240	\$328.00
25	FOIL-25-240	15'	300	1.25	192	\$349.00
40	FOIL-40-240	24'	480	2.00	120	\$464.00
50	FOIL-50-240	30'	600	2.50	96	\$589.00
60	FOIL-60-240	36'	720	3.00	80	\$709.00
70	FOIL-70-240	42'	840	3.47	69	\$829.00
95	FOIL-95-240	57'	1140	4.70	51	\$1,119.00
115	FOIL-115-240	69'	1380	5.71	42	\$1,249.00
130	FOIL-130-240	78'	1560	6.48	37	\$1,429.00
140	FOIL-140-240	86'	1680	7.05	34	\$1,579.00

Code	Accessories	Canada
ACC-DGMTR	The Alligator Tester - Digital Multimeter.	\$30.00
RL-240V25A	General purpose 25A/240V relay used to expand the switching capability of the Warmup thermostats. Mounts in single gang box.	\$114.00
DCM-SP-10K	Additional Floor Sensor.	\$27.00
SR-TAPE-AL	Aluminum Foil Tape for grounding - Sold in 90ft roll.	\$29.00
ACC-WATCHDOG	The Watch Dog Tester - Sounds an alarm when connected to a broken heating cable.	\$28.00

Code	Thermostats	Canada
6IE-04-CW-LC	Warmup's most popular thermostat, the white WiFi 6iE® featuring a smartphone quality touch-screen.	\$320.00
TRA-04-WH-LC	Warmup Terra Smart WiFi Thermostat with a minimal display for a contemporary look.	\$307.00
RFT-P-WH	Warmup's basic, programable thermostat with touch buttons and probe.	\$199.00

Code	Insulation	Canada
WIB-SOFT-1/4-110	4' wide Warmup Insulated Underlay sold in 110 sqft rolls.	\$168.00

\*The FOIL product requires an underlay. Approved carpet padding and polyurethane sound barriers are acceptable underlay.





# WODH In-Slab Cable

## Cable System for Slab Pours up to 6"

The Warmup In-Slab Cable System is designed for use within a concrete slab. The cable spacing can be altered to fit the heating requirements and the thickness of the slab. Warmup WODH cables provide 20W/sqft or up to 70 BTUs/hour and easily replace water-based applications. With an electric system, there is no boiler, no noise, no dust movement, no pump, no manifolds, and no maintenance required. It is the ideal solution for builders and remodelers in basements and room additions.

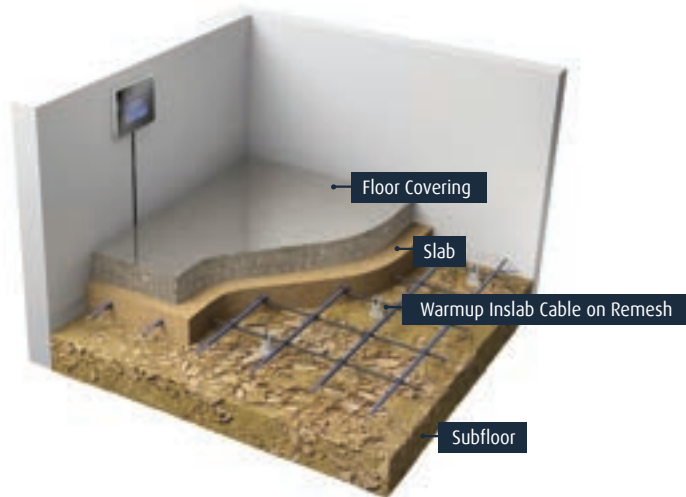

### Quote in 3 Easy Steps:

1. Cable
2. Accessories
3. Thermostat



Cable length	Code	Cable Spacing			Wattage	Amps	Resistance (Ω)	Canada
		3"	4"	5"				
93	WODH-240/500	24	30	39	500	2.1	114.30	\$383.00
176	WODH-240/950	44	59	74	950	4.0	60.00	\$586.00
250	WODH-240/1300	62	84	104	1300	5.4	44.40	\$674.00
315	WODH-240/1700	76	104	130	1700	7.1	33.80	\$861.00
437	WODH-240/2400	105	146	182	2400	10.0	24.00	\$1,159.00
625	WODH-240/3400	155	210	260	3400	14.2	16.90	\$1,364.00

Code	Accessories	Canada
ACC-DGMTR	The Alligator Tester Digital Multimeter.	\$30.00
DCM-SP-10K	Additional Floor Sensor.	\$27.00
RL-240V25A	General purpose 25A/240V relay used to expand the switching capability of the Warmup thermostats. Mounts in single gang box.	\$114.00
DCM-FB-82	Metal fixing strips to fix the heating cable - 82 ft long.	\$136.00
SR-ZT-100	Bag of 100 Heavy Duty Zip Ties.	\$27.00

Code	Thermostats	Canada
6IE-04-CW-LC	Warmup's most popular thermostat, the white WiFi 6IE® featuring a smartphone quality touch-screen.	\$320.00
TRA-04-WH-LC	Warmup Terra Smart WiFi Thermostat with a minimal display.	\$307.00
RFT-P-WH	Warmup's basic, programable thermostat with touch buttons and probe.	\$199.00

# Ultralight Insulation Boards

## 4-in-1: Insulating, Heat Spreading, Decoupling, Acoustic

Ultralight™ is a specialized composite board designed for floor heating applications. Manufactured as flat, flexible sheets, they are water and mold resistant. The top surface incorporates a heat spreading aluminium layer combined with non-woven fleece. The core of polyethylene foam (PEF) insulation provides thermal separation from the floor beneath, ensuring a rapid thermal response of a heated layer of tiles or leveling compound above.

### Features and Benefits:

- Improves comfort and reduces running costs
- Reduces heat-up times by 76 minutes
- Protection against tiles cracking
- Tested and rated for its acoustic performance
- Lighter and easier - won't break if bent or dropped
- Heavy Commercial and Light Commercial rating
- Easier to cut curves and complex shapes compared with cement-based tile insulation

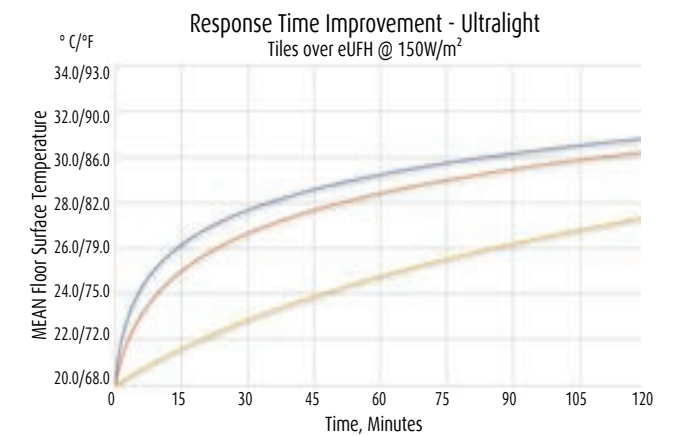

Code	Description	Canada
WCI-1	Warmup Ultralight Underfloor Heating Boards, 3'3x 2'3 x 1/4" (985mm x 678mm x 6mm) Single Board. (order of 5 minimum).	\$37.72
WCI-10	A box of 10 Warmup Ultralight Underfloor Heating Boards, 3'3x 2'3 x 1/4" (985mm x 678mm x 6mm). Covering 71.8sqft.	\$377.21

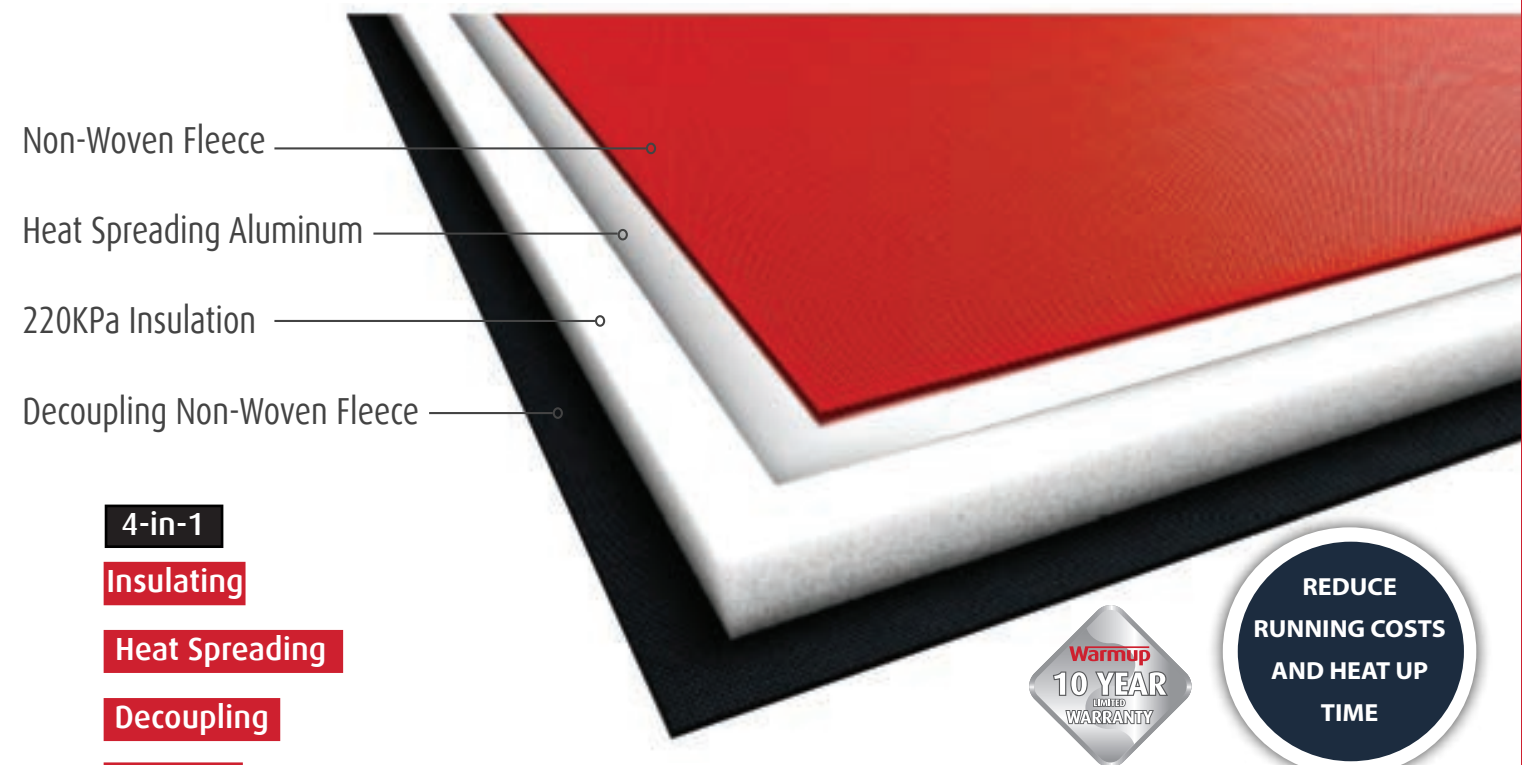

**REDUCE  
RUNNING COSTS  
AND HEAT UP  
TIME**

# Thermostats

Our Smart Thermostats can learn your habits, making sure your home is always at the right temperature, at the right time, for you. These controllers utilize Smartphone-based technology such as the MyHeating app which provides remote access to your heating system, automatic heat functionality, and can help save you money on your heating bills too.

**“Alexa, set living room thermostat to 85 degrees.”**



Code	Color	WiFi/ Non WiFi	Max Load	Warranty	Canada
6iE-04-CW-LC	White	WiFi	15A	12 year	\$320.00
TRA-04-WH-CL	White	WiFi	15A	12 year	\$307.00
RFT-P-WH*	White	Non WiFi	15A	3 year	\$199.00

All thermostat boxes include one floor sensor DCM-SP-10K

\*While supplies last

\*\*All 6iE® and Terra models have a built-in Class A GFCI and can operate systems at 120, 208 or 240V, via ambient and floor sensor

### Sensors:

Code	Color	WiFi/ Non WiFi	Max Load	Warranty	Canada
DCM-SP-10K**	White	N/A	N/A	N/A	\$27.00
RL-120V25A	N/A	N/A	N/A	25A	\$114.00
RL-240V25A	N/A	N/A	N/A	25A	\$110.00

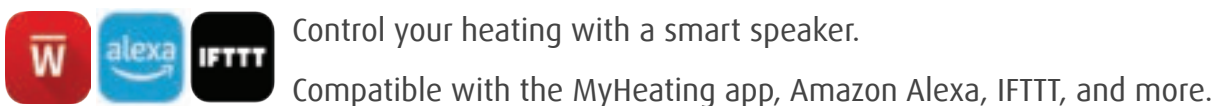

# Thermostat Features & Benefits

Our range of heating controllers for electric underfloor heating systems utilize advanced technology to improve your home's energy-efficiency. Increase your warranty from 3 years to 12 years when installed with a Warmup heater.

Visit <https://tools.warmup.com/us/register-warranty> for more information.

- Intuitive, Energy-Saving Heating Controls
- Remote access to your heating system via the MyHeating app
- Reduces Heating Bills
- SmartGEO Technology
- Weather Based Early Start
- Aesthetic Design
- Touchscreen
- Easy to Use



## Thermostat Installation

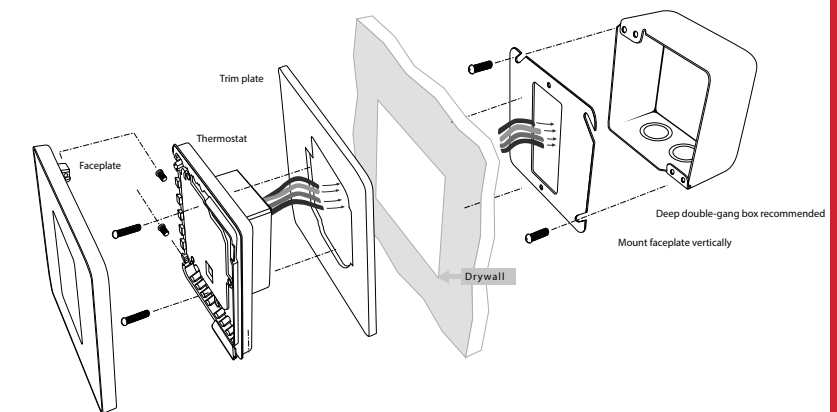
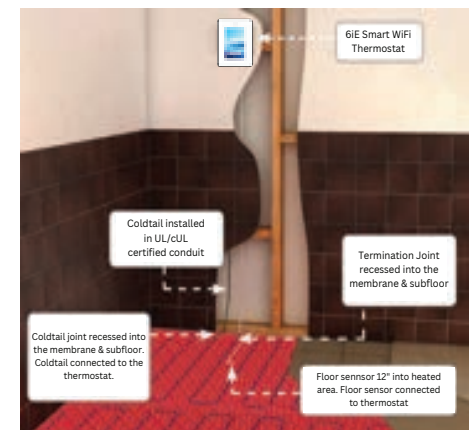



Turn your bathroom  
into a spa™

## Matte Black

### DID YOU KNOW?

Warmup's unique 001 and 002 models are recommended in sets of 4 or more for best results. Mounting bracket included.

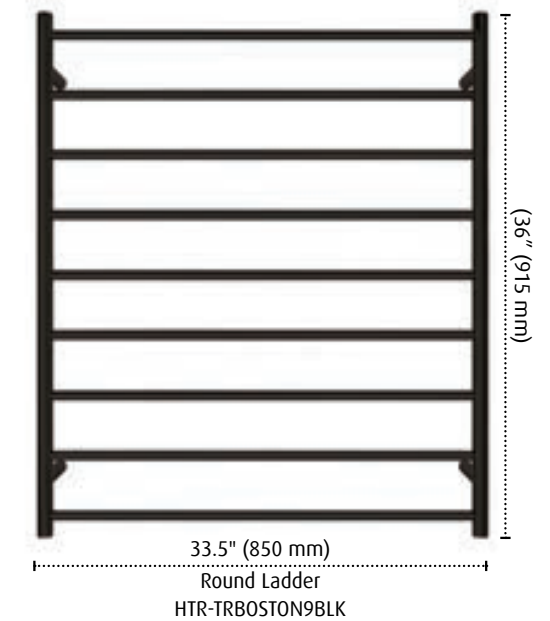
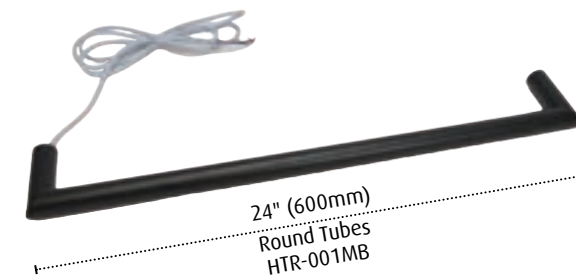
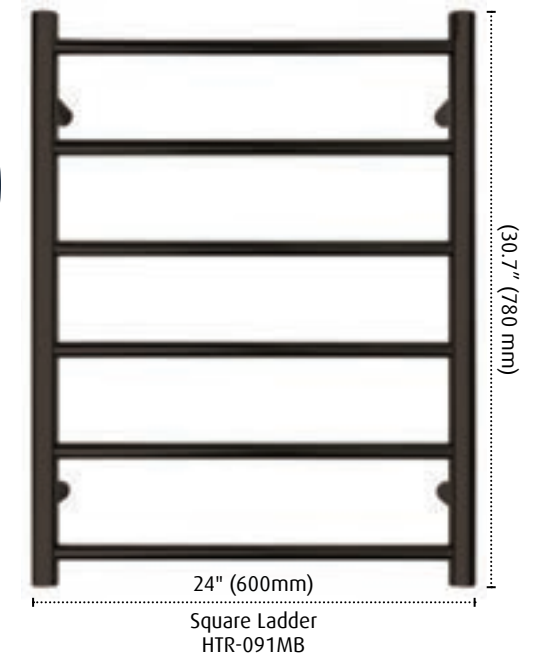
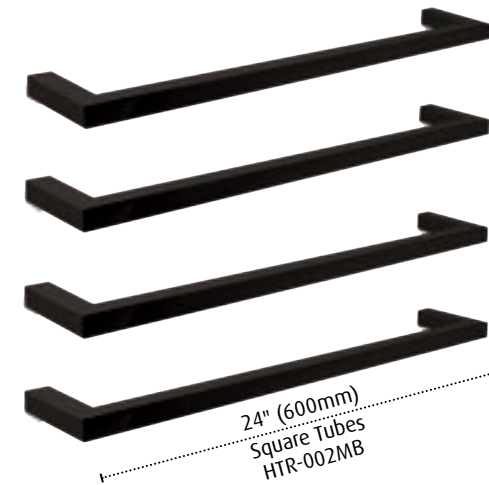

Code	Description	Wattage	Size	Canada
HTR-001MB	Single matte black round tube towel warmer. 3-year Warranty.	14	24"	\$164.00
HTR-002MB	Single matte black square tube towel warmer. 3-year Warranty.	14	24"	\$178.00
HTR-091MB	Ladder type matte black square tube towel warmer. 3-year Warranty.	60	24" x 30.7"	\$515.00
HTR-109SB	Ladder type stainless steel in powder coated satin black 9 bar heated towel rail with 304 grade. 2-year Warranty.	120	33.5" x 36"	\$668.00

\*Switch or Timer not included

# Brushed Stainless

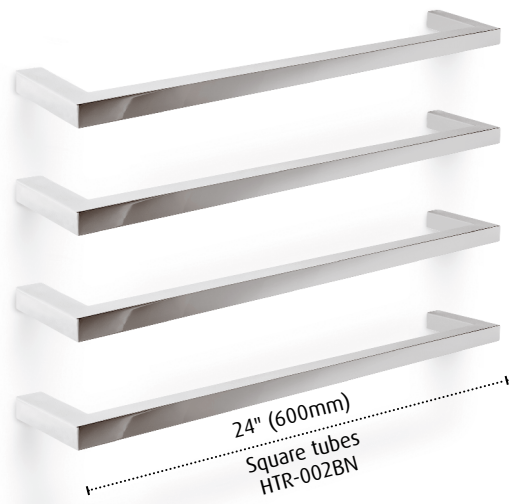

**DID YOU KNOW?**  
Warmup's unique 001 and 002 models are recommended in sets of 4 or more for best results. Mounting bracket included.



Code	Description	Wattage	Size	Canada
HTR-002BN	Single brushed nickel square tube towel warmer.	14	24"	\$178.00
<del>HTR-107BN</del>	<del>Ladder style square tube towel warmer with 7 bars.</del> *Discontinued	<del>80</del>	<del>24.5" x 36"</del>	<del>\$646.00</del>
HTR-110BN	Ladder style square tube towel warmer with 10 bars.	110	24.5" x 53"	\$832.00

\*Switch or Timer not included

# Polished Stainless

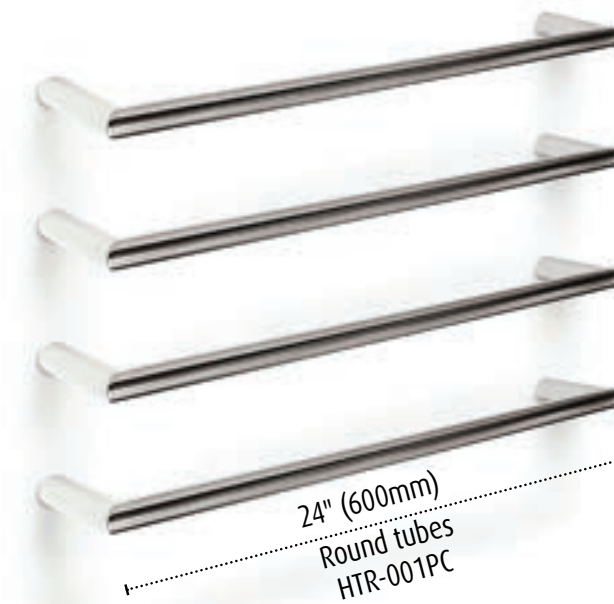

**DID YOU KNOW?**  
You can see all of our available towel warmers at [www.warmup.com](http://www.warmup.com) or [www.warmup.ca](http://www.warmup.ca)



Scan to find out more!

Code	Description	Wattage	Size	Canada
HTR-001PC	Single polished chrome round tube towel warmer.	14	24"	\$164.00
HTR-090PC	Ladder style towel warmer with 6 curved bars.	90	24.5" x 27.5"	\$648.00
<del>HTR-021PC</del>	<del>Ladder style towel warmer with 6 round bars.</del> *Discontinued	<del>60</del>	<del>24.5" x 27.5"</del>	<del>\$485.00</del>

\*Switch or Timer not included



# Plan for a safe & maintenance-free winter with Warmup® Snow Melting Solutions

## Residential Driveway

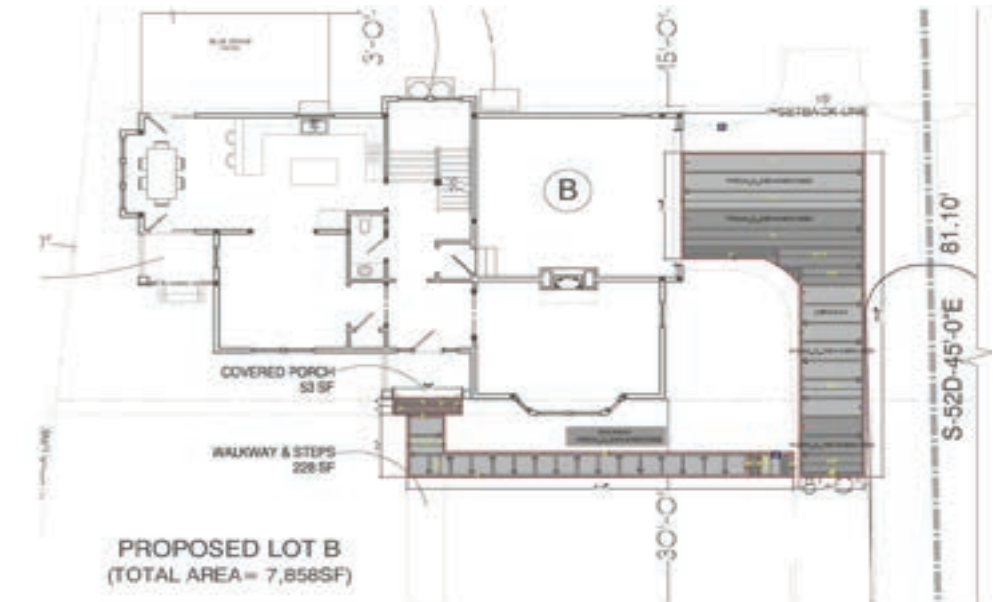

Size		Cost		Type	
480 Sqft		\$11,081.00		SNOPRO-100 WIFI	
Total Area	600 Sqft	US	CA	Specifications	CA
Heating System	OD-WSMM-240/6000 x2	\$2,562.00	\$3,202.00	Voltage	240
Heating System	OD-WSMM-240/4500	\$970.00	\$1,211.00	Amps	100
Heating System	OD-WSMM-240/2500	\$590.00	\$739.00	Total Wattage	24,000
Heating System	OD-WSMM-240/5000	\$1,068.00	\$1,334.00		
Controller	ODC-SNOPRO-100-W	\$3,590.00	\$4,595.00		
		Subtotal	\$8,780.00	\$11,081.00	



# Snow Melting Cables

For custom layouts and spacing under asphalt, concrete, and pavers.

Snow Melting Cables are the loose equivalent of the Mats. The Cables are reinforced with advanced fluoropolymer coatings to form a cable jacket that can withstand traffic and setting material. Warmup's Cables are completely grounded and safe for installation under asphalt, concrete, and pavers. Choose the loose format for stairs and odd-shaped areas and combine with Mats wherever necessary.

## Features & Benefits

- Versatile installation in asphalt, concrete or under pavers
- Flexible cable: quick and easy to install in every configuration
- Dual conductor cable, one-point connection
- Available in a wide range of lengths to suit your requirements



## Technical Specifications

- Operating voltage: 208V, 240V, 480V, and 600V
- Output rating: 50W/sqft @ 240Vac, 3" on center
- Energy efficient twin-conductor heating cable of 1/4"
- Wire jacket rated to take maximum asphalt pour temperatures of 464°F (240°C)
- Cold tail length: 16'4"
- 10-Year Warranty



Voltage	Length (ft)	Code	3"	4"	5"	Wattage	Amps	Resistance (Ω)	Canada
240V*	84	WSM-240/1000	20	27	34	1000	4.2	57.1	\$339.00
	168	WSM-240/2000	43	57	72	2000	8.3	28.9	\$523.00
	209	WSM-240/2500	51	67	84	2500	10.4	23.1	\$672.00
	251	WSM-240/3000	62	84	104	3000	12.5	19.2	\$724.00
	330	WSM-240/4000	85	110	135	4000	16.90	14.2	\$957.00
	420	WSM-240/5000	100	140	170	5000	20.86	11.5	\$1,159.00
	500	WSM-240/6000	122	181	200	6000	25.0	9.6	\$1,372.00

\*All mats can be connected to 208V and 240V single phase. Please check our Technical Data Sheets for variations to Wattage output and Amperage Load under different Voltages.

Voltage	Length (ft)	Code	Wattage	Amps	Resistance (Ω)	Canada
600V	84	WSM-600/1000	1000	1.7	360	\$345.00
	209	WSM-600/2500	2500	4.2	144	\$687.00
	342	WSM-600/4000	4000	6.7	90	\$983.00
	500	WSM-600/6000	6000	10	60	\$1,410.00

\*Special order items - can take up to 16 weeks to come in.

Code	Accessories	Canada
WSM-NMP	Branded Name Plate for use with Warmup Snow Melt Heater installations (NEC426-13).	\$56.00
ACC-DGMTR	The Alligator Tester - Digital Multimeter.	\$27.00
DCT-SBOX	The Dual Cable Tester monitors up to two cables concurrently and monitors the integrity of both the core to core and core to ground resistance.	\$60.00
SR-ZT-100	Bag of 100 Heavy Duty Zip Ties - 7" long. For use with WSM, WODH and SR cable series - 50lbs load bearing capacity.	\$27.00
DCM-FB-82	Metal fixing strips to fix the heating cable - 83 ft long.	\$26.00
RK-EO	Repair kit for Warmup® Outdoor Heating Cable.	\$13.00





# Snow Melting Mats

For custom layouts and spacing under asphalt, concrete, and pavers.

Warmup systems are ideal to provide snow-free access to the house and prevent injuries on stairs and walkways. They are commonly used in concrete pours, asphalt driveways, and paved walkways. Mats are 2ft or 3ft wide and with a 3" cable spacing providing 50W/sqft for optimum results under even the harshest conditions. Refer to the installation manual for weight requirements.

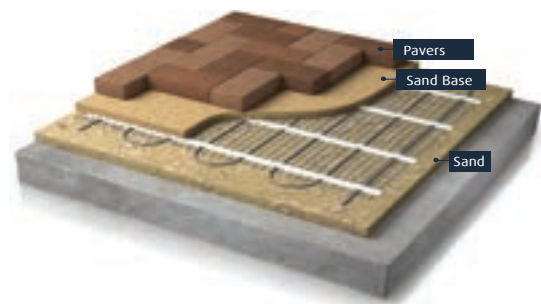
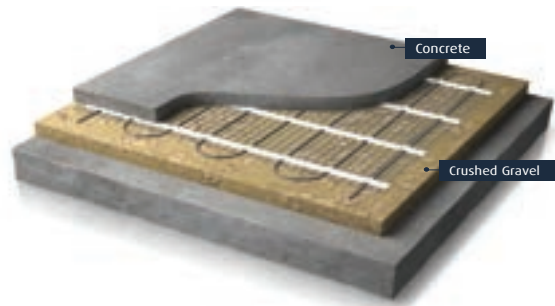
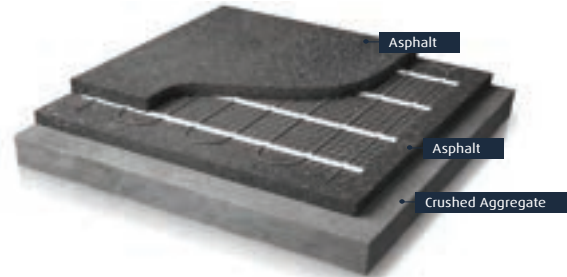

## Features & Benefits

- Versatile installation in asphalt, concrete, or under pavers
- Dual conductor cable, one-point connection
- Available in a wide range of lengths to suit your requirements
- Available in 2 ft and 3 ft wide rolls

## Technical Specifications

- Operating voltage: 208V, 240V, and 480V
- Output rating: 50W/sqft at 240V
- Rated to a maximum temperature of 464°F (240°C) under asphalt pours
- Cold tail length: 16'4"
- 10-Year Warranty



Voltage	Area (sqft)	Code	Mat Length (ft)	Wattage	Amps	Resistance (Ω)	Canada
240V**	10	WSMM-240/500	5	500	2.1	115.20	\$247.00
	20	WSMM-240/1000	10	1000	4.2	57.60	\$336.00
	30	WSMM-240/1500	15	1500	6.3	38.40	\$446.00
	40	WSMM-240/2000	20	2000	8.3	28.80	\$528.00
	50	WSMM-240/2500	25	2500	10.4	23.00	\$590.00
	60	WSMM-240/3000	30	3000	12.5	19.20	\$740.00
	70	WSMM-240/3500	35	3500	14.6	16.46	\$818.00
	80	WSMM-240/4000	40	4000	16.7	14.40	\$898.00
	90	WSMM-240/4500	45	4500	18.8	12.80	\$970.00
	100	WSMM-240/5000	50	5000	20.8	11.50	\$1,068.00
120	WSMM-240/6000	60	6000	25.0	9.60	\$1,281.00	

Voltage	Area (sqft)	Code	Mat Length (ft)	Wattage	Amps	Resistance (Ω)	Canada
240V**	30	WSMM-240/3x10	10	1500	6.3	38.4	\$450.00
	60	WSMM-240/3x20	20	3000	12.5	19.2	\$722.00
	75	WSMM-240/3x25	25	3750	15.6	15.6	\$824.00
	90	WSMM-240/3x30	30	4500	18.8	12.8	\$991.00
	120	WSMM-240/3x40	40	6000	25.0	9.6	\$1,238.00

\*All mats can be connected to 208V and 240V single phase. Please check our technical data sheets for variations to wattage output and amperage load under different voltages.

Code	Accessories	Canada
WSM-NMP	Branded Name Plate for use with Warmup Snow Melt Heater installations (NEC426-13).	\$45.00
ACC-DGMTR	The Alligator Tester - Digital Multimeter.	\$21.00
DCT-SBOX	The Dual Cable Tester monitors up to two cables concurrently and monitors the integrity of both the core to core and core to ground resistance.	\$60.00
SR-ZT-100	Bag of 100 Heavy Duty Zip Ties. 7" long. For use with WSM, WODH and SR cable series. 50lbs load bearing capacity.	\$21.00
RK-E0	Repair kit for Warmup® outdoor heating cable.	\$20.00

# Sensors, Panels, & Controls

Elevate your outdoor space.

The anatomy of an outdoor system consist of a contactor panel and/or a control panel, sensors, and heating cable(s). Often times, these two devices are put together in one unit. As an option, you may also need a sensor to trigger the system.

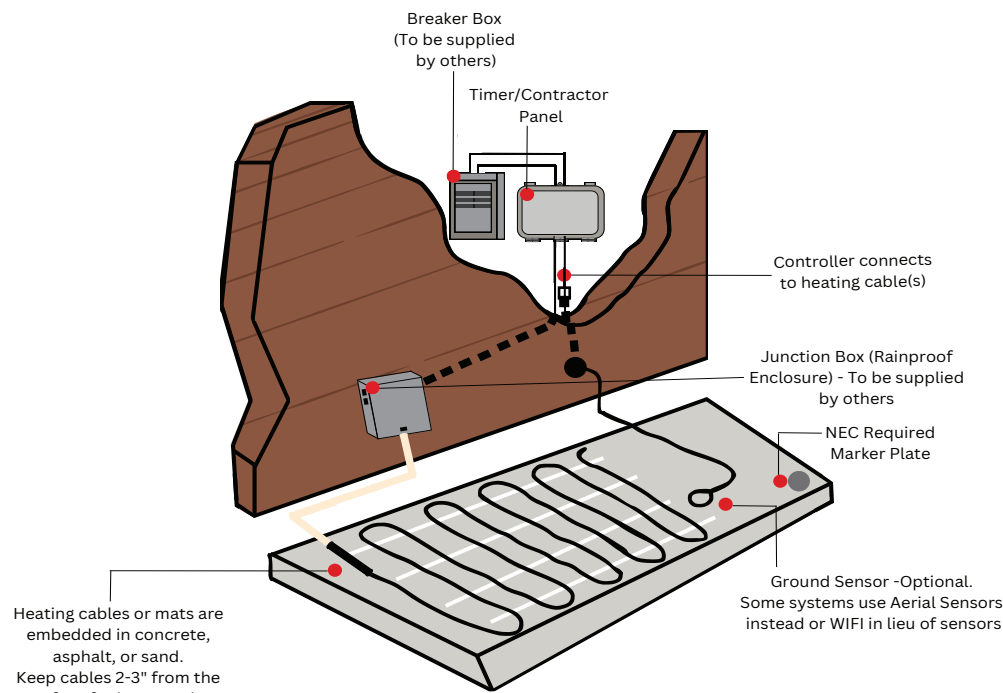

Control	Sensors & Accessories
SNOPRO-100 Series	PRO-A  PRO-R  PRO-G-H  PRO-REMOTE
Control	Sensors & Accessories
Combox-600	ODC-AIRSS  ODC-AIRSS-B
Control	Sensors & Accessories
DS Series	ODC-GF-1  ODC-GF-2  ODC-CDP-2



The SNOPRO-100-W Compatible with the "Warmup WSM" app

# Snow Melting Controls, Sensors, & Accessories

A set up for every project and every budget.

## Controls

Code	Description	Canada
SNOPRO-100	Snow/Ice Melt All-In-One Control Unit, an exceptionally capable deicing controller. Available in a single phase or three-phase. 208V-600V.	\$3,648.00
SNOPRO-100-W	Snow/Ice Melt All-In-One Control Unit, an exceptionally capable deicing controller. Compatible with the Warmup WSM Snowmelting App. Available in a single phase or three-phase. 208V-600V.	\$4,595.00
ODC-ASE-DS2C	Snow/Ice Melt All-In-One Control Unit, 1 Zone control, ground and roof, 120/240V, 30 amps.	\$936.00
ODC-ASE-DS5C	Snow/Ice Melt All-In-One Control Unit, 2 Zone control, ground and roof, 120/240V, 60 amp (2 x 30 amps contactors).	\$1,083.00
ODC-ASE-DS8C	Snow/Ice Melt Control Unit, 100-277 VAC Universal Input Power Supply, 1x30A SPST Load Contactor, remote moisture sensor, roof, 120/240VAC, 30 amps.	\$1,085.00
ODC-ASE-DS9C	Snow/Ice Melt Control Unit, 100-277 VAC Universal Input Power Supply, 2x30A SPST Load Contactor, remote moisture sensor, roof, 120/240VAC, 60 amps.	\$921.00
ODC-RESIBOX3	Plug-and-Play outdoor controller with 4 x 30A/2pole contactors allowing for a total load of 120A with a minimum power supply of 36A. Comes in LED enclosure with GFEP protection, built-in digital controller and ground temperature sensor. AIRSense sold separately.	\$1,153.00
ODC-COMBOX600	Plug-and-Play outdoor controller with 4 x 50A/3pole contactors allowing for a total load of 600A with a minimum power supply of 150A (3-phase power). 230A Max load at 240V supply. Comes in LED enclosure with GFEP protection, built-in digital controller and ground temperature sensor. 3-Phase power and any transformers are the responsibility of the Electrical Contractor. AirSense sold separately.	\$7,853.00

## Sensors

Code	Description	Canada
ODC-PRO-A	24V Aerial Moisture and Temperature sensor for SNOPRO and other controllers.	\$1,323.59
ODC-PRO-R	24v Gutter Moisture and Temperature sensor for SNOPRO and other controllers.	\$1,388.00
ODC-PRO-G-H	Surface-mounted snow and ice sensor for SNOPRO panel. Detects moisture and temperature and triggers below 38F. Housing included.	\$3,392.00
ODC-SNOPRO-EXT	WiFi Module To Convert Non-WiFi SNOPRO-100 To WiFi. *Special order only.	\$2,474.00
ODC-AIRSS	Outdoor moisture and temperature sensor for use with the ComBox/ResiBox.	\$1,108.00
ODC-AIRSS-B	Mounting bracket for AIRSense Sensor.	\$281.00

## Accessories

Code	Description	Canada
PRO-REMOTE	A remote control and status display to the SNOPRO-100 or satellite controls at a location convenient to personnel capable of observing snow melting system operation.	\$819.00
ODC-CDP-2	Indoor Monitoring and Control for Roof and Gutter Cable & Snow Melting, Self Powered, fits Any Standard Single Gang or Multi-Gang Electrical Enclosure. Fits all DS series controllers.	\$373.00
ODC-CS-50	50ft connection kit between DS Controller and CDP-2 remote.	\$159.00
ODC-GF-1	In-line Ground Fault Equipment Protection Device for one circuit up to 60A load at 120/208/240V. 30mA trip level. NEMA 4X/IP65 enclosure.	\$835.50
ODC-GF-2	In-line Ground Fault Equipment Protection Device for two circuits up to 63A load each at 120/208/240V. 30mA trip level. NEMA 4X/IP65 enclosure.	\$1,236.00



Plan for a safe & maintenance-free winter with Warmup®

# Roof & Gutter and Pipe Freeze Protection



## Self-Regulating Cable for Pipe Freeze Protection & Roof and Gutter Delcing Systems: Jacketed

Warmup's Self-Regulating Cable solutions provide reliable protection against snow and ice build-up on roof and gutter applications. The Cable adjusts to outdoor conditions thanks to its inner carbon matrix and will allow higher heat outputs when conditions worsen. All Cables are reinforced with a durable jacket and are UV resistant. The Warmup Cable presents a very low rush-in current allowing for maximum footage per breaker.

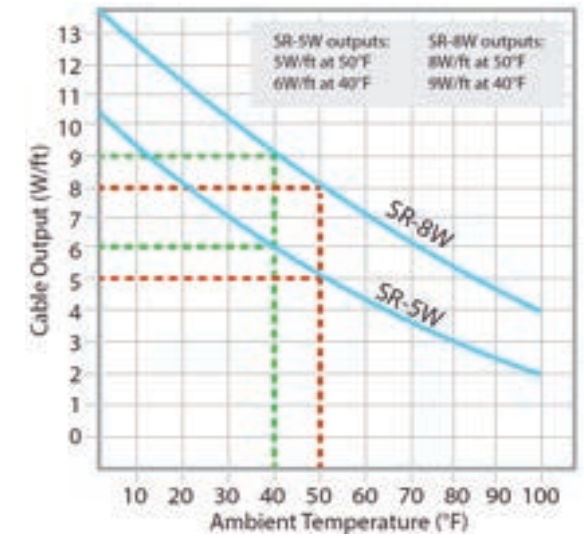

	Code	Description	Canada
120V	SR-5W-1-250	Self-Regulated 16GA Cable, 120V, 5W/linear foot. Sold in 250' length spools.	\$2,116.00
	SR-5W-1-500	Self-Regulated 16GA Cable, 120V, 5W/linear foot. Sold in 500' length spools.	\$4,230.00
	SR-5W-1-1000	Self-Regulated 16GA Cable, 120V, 5W/linear foot. Sold in 1000' length spools.	\$8,458.00
	SR-8W-1-250	Self-Regulated 16GA Cable, 120V, 8W/linear foot. Sold in 250' length spools.	\$2,178.00
	SR-8W-1-500	Self-Regulated 16GA Cable, 120V, 8W/linear foot. Sold in 500' length spools.	\$4,355.00
	SR-8W-1-1000	Self-Regulated 16GA Cable, 120V, 8W/linear foot. Sold in 1000' length spools.	\$8,707.00
240V	SR-5W-2-250	Self-Regulated 16GA Cable, 240V, 5W/linear foot. Sold in 250' length spools.	\$2,116.00
	SR-5W-2-500	Self-Regulated 16GA Cable, 240V, 5W/linear foot. Sold in 500' length spools.	\$4,230.00
	SR-5W-2-1000	Self-Regulated 16GA Cable, 240V, 5W/linear foot. Sold in 1000' length spools.	\$8,458.00
	SR-8W-2-250	Self-Regulated 16GA Cable, 240V, 8W/linear foot. Sold in 250' length spools.	\$2,178.00
	SR-8W-2-500	Self-Regulated 16GA Cable, 240V, 8W/linear foot. Sold in 500' length spools.	\$4,355.00
	SR-8W-2-1000	Self-Regulated 16GA Cable, 240V, 8W/linear foot. Sold in 1000' length spools.	\$8,707.00
120V	SR-K6FT	Self-Regulating Kit with Plug, 6ft	\$104.00
	SR-K12FT	Self-Regulating Kit with Plug, 12ft	\$151.00
	SR-K18FT	Self-Regulating Kit with Plug, 18ft	\$192.00
	SR-K24FT	Self-Regulating Kit with Plug, 24ft	\$214.00
	SR-K50FT	Self-Regulating Kit with Plug, 50ft	\$392.00
	SR-K75FT	Self-Regulating Kit with Plug, 75ft	\$482.00
	SR-K100FT	Self-Regulating Kit with Plug, 100ft	\$614.00

\*Available in cut-to-length spools or plug-in kits, the Warmup Cable is applicable on metal, PVC, and ceramic pipes, sprinkler systems, and sewer drains.

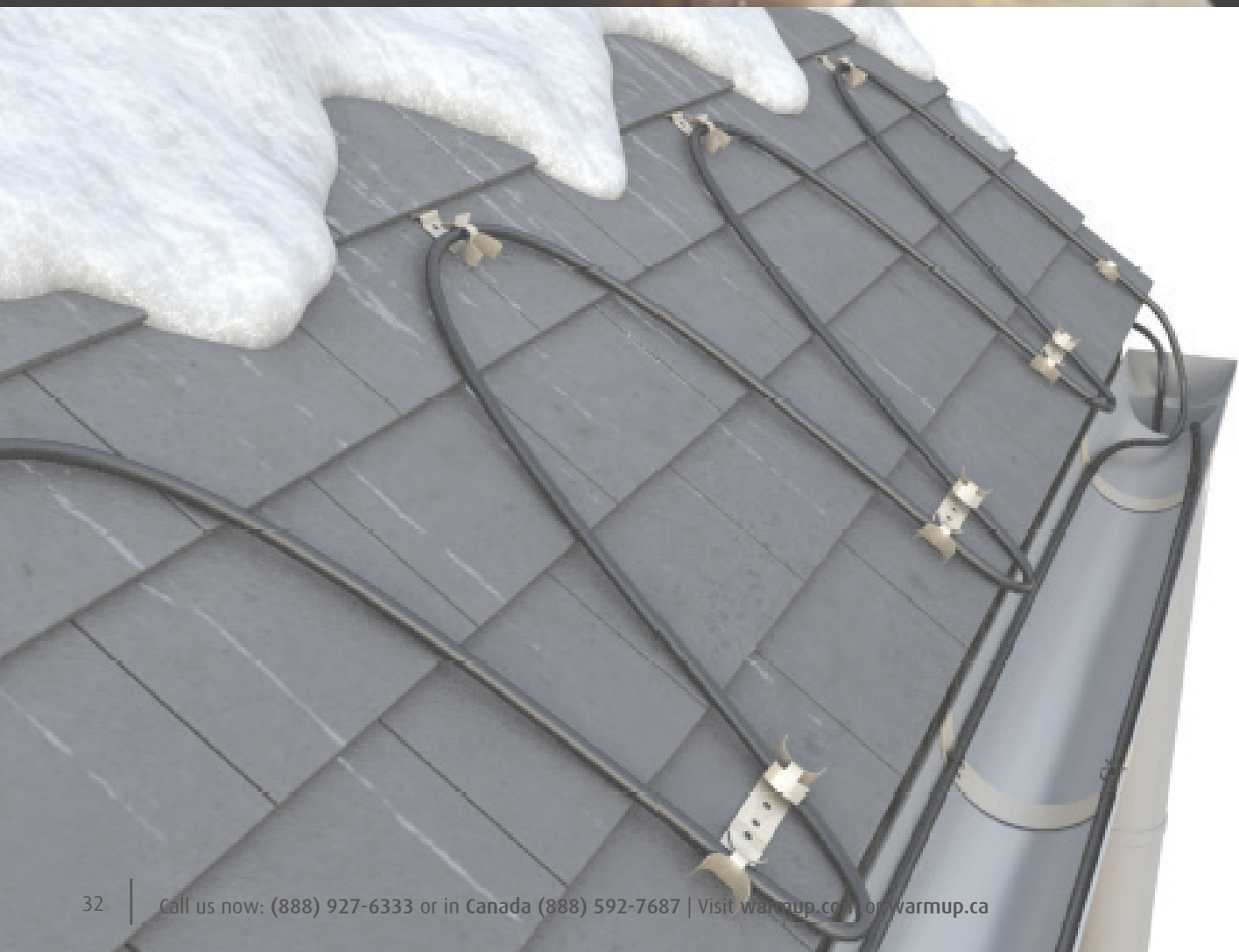

# Roof & Gutter Deicing Systems

The Warmup WRGH Cable is a constant wattage roof de-icing system supplied in pre-terminated plug-in kits with roof clips and spacers. WRGH kits are sold pre-assembled with a 3-prong plug in order to provide a simple, DIY solution to resolve ice dams and snow accumulation on roof lines. An optional WRS-2 Controller can be purchased to reduce usage and electrical draw when temperatures are above 40°F. It is highly recommended to increase product life and to reduce risk of fires or burn outs.

Code	Length in Feet	Wattage	Voltage	W/lin. ft	Canada
WRGH-120-150	30	150	120	5	\$121.00
WRGH-120-300	60	300	120	5	\$157.00
WRGH-120-400	80	400	120	5	\$199.00
WRGH-120-500	100	500	120	5	\$225.00
WRGH-120-600	120	600	120	5	\$279.00
WRGH-120-800	160	800	120	5	\$330.00
WRGH-120-1000	200	1000	120	5	\$393.00
WRGH-120-1200	240	1200	120	5	\$428.00

Code	Description	Canada
ODC-WRS-2	Moisture & Temperature Controller for Warmup WRGH Roof & Gutter De-Icing Kits.	\$163.00

## Technical Specifications

- Not suitable for Pipe Freeze Protection
- Do not overlap or terminate cable
- Turn system off after the snow season
- Must be connected to GFCI protected outlet or breaker



WRS-2 Controller



# Controllers, Sensors, & Accessories

## Roof & Gutter Controllers

Code	Description	Canada
ODC-SNOPRO-100	Warmup's Snow Melting Controller can be used with external sensors (PRO-R, PRO-A, and PRO-G) to activate snow melting. 120-240V, 50/60 Hz, 1 Phase, 50 Amp Max. Resistive with 2x50 Amp contactors and integrated GFEP.	\$3,648.00
ODC-ASE-DS8C	Snow/Ice Melt Control Unit, 100-277V Universal Input Power Supply, 1x30A SPST Load Contactor, remote moisture sensor, roof, 120/240V, 30 amps.	\$1,083.00
ODC-ASE-DS9C	Snow/Ice Melt Control Unit, 100-277V Universal Input Power Supply, 2x30A SPST Load Contactor, remote moisture sensor, roof, 120/240V, 30 amps.	\$1,085.00
ODC-RESIBOX3	Automatic Snow Melting Panel with 4 x 30A switching capability. Requires the gutter sensor.	\$5,399.00

## Pipe Trace Controllers

Code	Description	Canada
TRF115-005	Ambient temperature thermostatic control for Pipe Freeze Protection and De-Icing applications. Can be set from 0F to 120F trigger point. Comes with 5ft bulb sensor. 25A (120/208/240V).	\$245.00
ODC-TRACE-2*	"Plug and Play" controller and power panel for heat tracing cables on freeze protection and de-icing applications.	\$1,917.00



ODC-TRACE-2 TRF115-005

\*Only available for 240V. 120V can be special-ordered with an extended lead time of up to 16 weeks.

## Accessories

Code	Description	Canada
SR-SFIT-BOX-5	Power Connection Junction Box (6x6x3) with Pipe-Mounting Bracket for Self-Reg connections. Suitable for Roof & Gutter and Pipe Trace applications.	\$313.00
SR-SFIT-SPL	In-Line Splicing Box for fast and weather tight connections in the field. Suitable for Roof & Gutter and Pipe Trace applications.	\$92.00
SR-SFIT-TEE	3-Way T-Splice Box for fast and weather tight connections in the field. Suitable for Roof & Gutter and Pipe Trace applications.	\$99.00
SR-POWER-KIT	Power Connection Kit for Self-Regulating Cable. Includes pipe mounting bracket and an End Kit. Suitable for Roof & Gutter and Pipe Trace applications.	\$88.00
SR-SPLICE-KIT	Splice/Tee Kit for Self-Regulating Cable. Includes (2) end caps. Suitable for Roof & Gutter and Pipe Trace applications.	\$59.00
SR-END-KIT	End Seal Kit for Self-Regulating Cable. Suitable for Roof & Gutter and Pipe Trace applications.	\$31.00
SR-LENDCAP	Lit End Cap for Self-Regulating Cable. Suitable for Roof & Gutter and Pipe Trace applications.	\$384.00
SR-HANGER-KIT	Downspout Hanger for Self-Regulating Cable. Suitable for Roof & Gutter applications.	\$30.00
SR-TAPE-AL	Aluminum Foil Tape for Self-Regulating Cable. Sold in 90ft roll. Suitable for Pipe Trace applications.	\$29.00
SR-ROOF-CLIP	50 Metal Single Roof Clips secure to roof with screws or Everseal SB-170 adhesive or similar. Suitable for Roof & Gutter applications.	\$149.00
ODC-PRO-R	Gutter sensor for SNOPRO panel. Measures moisture & temperature. Active below 38°F.	\$1,388.00
SR-HTMK	Connection and end cap.	\$40.00
SR-PLUG	Simple thermostatic controller to activate at fixed temperature. Switch 16A @ 120V / 12A @ 240V.	\$33.00
SR-TAPE-UJ	Fiberglass Tape (1/2" x 60ft) for Self-Regulating Cable. Sold in 60ft roll. Suitable for Pipe Trace applications.	\$28.00
SR-ZT-100	100 Heavy Duty Zip Ties. 7" long. For use with WSM, WODH, and NAMS cable series. 50lbs load bearing capacity. Suitable for Pipe Trace applications.	\$29.00
SR-LBL	Pack of 10 warning labels. Suitable for Pipe Trace applications.	\$27.00
ODC-CDP-2	Indoor Monitoring and Control for Roof & Gutter Cable, Self Powered, fits Any Standard Single Gang or Multi-Gang Electrical Enclosure. Fits all DS series controllers.	\$373.00
ODC-CS-50	50ft connection kit between DS Controller and CDP-2 remote.	\$159.00
WRGH-SB-170	Versatile adhesive to apply the Warmup ROOF-CLIP on a variety of roof structures. It is water and weather proof with a strength of 2,000 psi. Suitable for Roof & Gutter applications.	\$47.00
CRDS-15-GFI	6ft lead with GFCI 3-prong molded plug, NEMA 5-15,15 amp, 14/3. Suitable for Roof & Gutter and Pipe Trace applications.	\$121.00



SR-SFIT-BOX SR-SFIT-SPL SR-SFIT-TEE END-KIT SR-TAPE-UJ SR-PLUG SR-HTMK SR-LENDCAP



# Warmup

The world's **best-selling** floor heating brand™



Warmup Inc.  
USA

T: (888) 927-6333  
F: (888) 927-4721

[www.warmup.com](http://www.warmup.com)  
[ussales@warmup.com](mailto:ussales@warmup.com)



Warmup Inc.  
Canada

T: (888) 592-7687  
F: (888) 927-4721

[www.warmup.ca](http://www.warmup.ca)  
[ca@warmup.com](mailto:ca@warmup.com)



Warmup Inc.  
Mexico

T: +52 (55) 8114 0145  
O: +52 (55) 8114 0146

[www.warmup.com.mx](http://www.warmup.com.mx)  
[mexico@warmup.com](mailto:mexico@warmup.com)

## QUESTIONS / QUOTES

[ussales@warmup.com](mailto:ussales@warmup.com)

For sales support and quotes in just 24 hours, contact us at [ussales@warmup.com](mailto:ussales@warmup.com)

## ORDERS / BILLING

[us@warmup.com](mailto:us@warmup.com)

For inquiries regarding orders & billing, contact us at [us@warmup.com](mailto:us@warmup.com)

## TECHNICAL

[warmup.ca/warmupedia](http://warmup.ca/warmupedia)

Warmupedia documents installation tips and troubleshooting guides for all Warmup products