

Warmup[®]

The world's best-selling electric floor heating brand[™]

Installation Manual: In-slab Heating Cable Thermal Storage Heating

IMPORTANT

Read this manual before attempting to install your heater. Incorrect installation could damage the heater and will invalidate your warranty.



TECHNICAL HELP LINES







US: +1-888-927-6333

Canada: +1-888-592-7687

Contents

Do's and Don'ts	2
The product	3
Subfloor considerations	4
Installation using fixing strips	5
Installation using wire-mesh	6-8
Connect Thermostat and Testing	9
Warranty / Terms and Conditions	10-11
Cable Sizing and Spacing Guide	Back cover

Do's & Dont's

-  **The cable must be spaced evenly at all times to ensure an evenly heated floor. The bend radius of the wire must NOT be less than 2" (50mm).**
-  **The cables must never touch or cross each other (min. separation is 2" [50mm]).**
-  **The cable must not be cut, damaged or shortened.**
-  **The entire cable, including joints, must be laid in concrete.**
-  **Do not activate the cables until the concrete has fully cured.**
-  **Do not install the cable up walls.**
-  **When using insulation, separate the cable from the insulation layer or boards by elevating the wire mesh.**

**1-888-927-6333 (US)
1-888-592-7687 (Canada)**

The Product

This product is a Warmup® In-slab Heating Cable. The cable has been designed to be placed within a slab of at least 2" (50mm) in thickness. The cable is a twin conductor surrounded by a ground shield for electrical protection. The cable is supplied with a 16 foot power supply lead wire for connection to a thermostat.

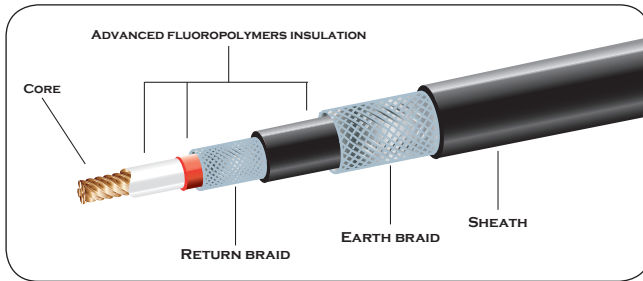

The product is designed for 240V supply installations- ensure the correct heater for the correct power supply has been purchased. Applications at 208V and 277V can be made effective with customized spacing of the heating cable. The cable produces between 10 to 20 Watts per sqft (100W to 200W/SQM) of heating, depending on the spacing of the cable (see Sizing Guide at the back of the manual). The product is CSA approved.

ELECTRICAL CONSIDERATIONS

Before installing the heating cable, a suitable 240V electrical supply must be located. Perform wiring in accordance to local electrical code. In bathrooms and wet areas, use GFCI protected breakers. All electrical installations must be carried out by a qualified electrician in accordance with local building and electrical codes, the NEC (article 424, part V, ANSI/NFPA 70 in the US) or the CEC Part I (in Canada).

The installation of more than one cable will require the cold tails to be connected to the thermostat in parallel and NOT in series. Installations involving more than 2 heating cables may require a junction box.

Caution should be taken to ensure that the combination of heaters does not exceed the maximum 15 amps supplied by the thermostat - see Heater Sizing & Wiring Spacing Guide on the back cover for amperage calculations. Use external relays or Warmup's RELAY-40 and RELAY-3x40 relays for zones larger than 15 amps.

**ALL electrical connections must be carried out by a qualified electrician.
ALL electrical regulations must be observed, including national and local codes.**

Subfloor considerations

Warmup In-slab Heating Cable is designed to be placed within the cementitious slab of at least 2" (50mm) in thickness, with at least 1 1/8" (30mm) of slab above the heating wire. For thicker pour of up to 6", elevate the wire mesh on which the cable is tied with bricks, wood blocks or other spacers to float the cable at the desired level. Depending on the construction of the subfloor and in general, in order to improve the efficiency of the system, you may need to apply insulation prior to the pour. See the diagrams below for details.

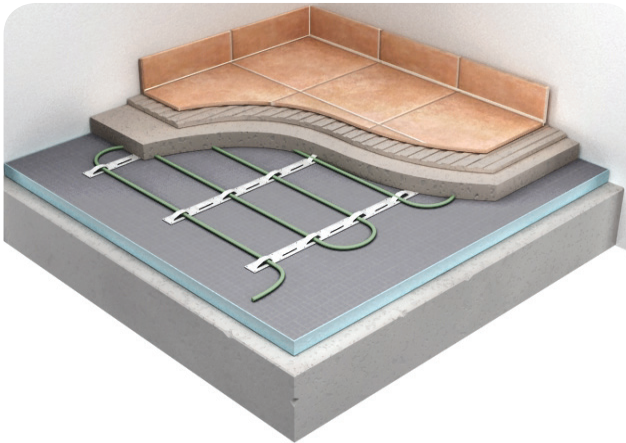
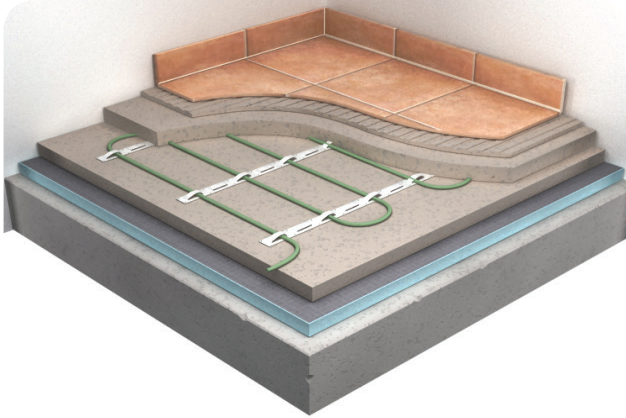

The subfloor of the project should be suitable for laying concrete. All normal requirements for laying concrete should be applied prior to installing the Warmup WODH systems.

Installation using fixing strips

It is advised that a floor plan is drawn up to determine the placement of the thermostat, heating cable and the sensor probe. This diagram should be kept for future reference. Warmup recommends taking pictures of the cable layout for future reference when drilling through the floor or attempting to troubleshoot the system.

The fixing strips should be laid out perpendicular to the heating cable runs. These fixing strips must be secured to the insulation or the concrete floor using fixing nails or an adhesive.

It is important to ensure there is no movement of the fixings.

The fixing strips should be evenly spread across the floor at interval of 30" (0.75m). The fixing strips should be placed so as to leave a minimum of 4" (100mm) border all the way around the room.

In most common instances, the cable will be zip-tied to a 16 Ga wire-mesh ("re-mesh" type) or similar with 4"x4" square openings. The mesh should be elevated as needed and leveled to the desire depth in relation to the size of the pour. Warmup recommends keeping the cable about 2" from the surface.

When apply the cable to an existing slab or substrate using metal fixing strips, these should be laid out perpendicular to the cable runs. Secure the fixing strips with screws, hot-glue/liquid nails or any suitable adhesive to avoid movement when looping and stretching the cables. Lay additional runs of strips where needed to avoid spans over 4 feet.

Examine the cable and test the resistance BEFORE and AFTER installation. Always record readings in the NOTES Section.

Check the resistance of heating cable and its insulation resistance with a digital multi-meter. The resistance value of the heating cable must match the value given in product range table. A tolerance of -5% to +10% is allowed. Insulation resistance must be more than 10Mohms. Record readings in the NOTES Section until you can complete the online warranty.

The heating cable should then be laid up and down the room and clipped into the fixing strip. The cable spacing is determined by the product model (see Sizing Guide on back). The cables should be spaced evenly at all times to ensure an evenly heated floor (minimum spacing is 2" (50mm)). The cables should never touch or cross each other.

The heating cable cold tail should be connected to the thermostat by a qualified electrician in accordance with NEC (USA) and CEC Part 1 (Canada). **The heating cables should then be tested again BEFORE POURING the layer of cement. Record the readings in the NOTES Section.** Once laid, the heating cables must be covered with a minimum thickness of 1¹/₈" (30mm) of cement.

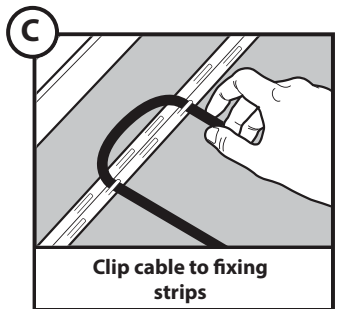
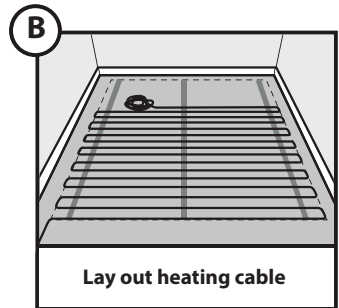
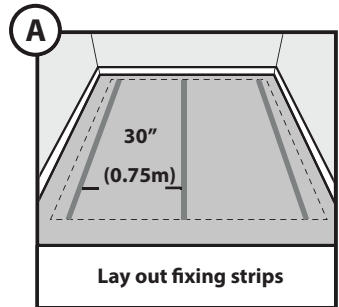

Installation on wire-mesh

Warmup In-slab Heating Cables are commonly zip-tied to wire mesh in concrete from a depth of, 1.5" to 3.0" below the surface. **The heating cable must not be cut or shortened.**

1. Once the on-centre-spacing (OC) has been worked out the cables can be tied to the mesh using plastic cable ties. Care must be taken not to tighten the ties too much causing damage to the cable. Any number of ties can be used ensuring that the on-centre-spacing is maintained. For ease of installation, cable lengths can be determined to match the mesh spacing. It is recommended to select a mesh with suitable openings that match the desired cable spacing. A 4" mesh is typical as 4" cable spacing is the norm. Use a 2" mesh and space the cable at 2" and 4" in alternation to obtain an average 3" spacing (higher output). Space at 4" and 6" in alternation for a 5" spacing (lower output, usually only applicable for installations with higher levels of insulation).
2. Position cables to avoid water pipes, drains and permanent fixtures that will be installed on the finished floor and require subsequent drilling. Perimeter cables should be run 4" away from walls and permanent fixtures.
3. Sketch your installation in advance, planning for cable run starts, sensor location and relays/thermostats. Provide such sketch as well as pictures to the homeowner for future use.
4. Plan for a 1-1/2" or 2" plastic PVC conduit with an elbow to run the cables up from the concrete pour and towards the thermostat up the wall. Rigid or locally suitable electrical conduits for the cable can be mounted for the thermostat by the electrician. About 4 cables can fit in a 1-1/2" pipe. The PVC conduit should only be long enough to bring the cables clear from the surface of the pour.
5. Install a 1/2" pipe (metal or PVC) for the floor sensor from the thermostat location. Similar to the lead cables above, secure sensor to mesh or fixing strips where suitable, and route the connecting end away from the pour via the pipe installed.

Installation using wire-mesh - continued

NOTE:

When using only the thermostat, both the sensor and the lead wires go directly to the thermostat.

When using a junction box for the lead wires (more than 2 lead wires), the sensor goes straight to the thermostat and the lead wires to the junction box. Home-run to the thermostat with a suitable xx/3 cable (live-live-ground).

When using relays (load over 15 Amps), the sensor still goes straight to the thermostat, but the lead wires will go to the relay directly.

7. Check the continuity, resistance and insulation resistance value during and after laying the heater wires. Check if these values are consistent with pre-installation values. Record the values for the warranty registration.
8. Once the cable has been installed, the sensor wire conduit positioned and the final resistances and continuity checked, the concrete floor can then be poured. Care must be taken not to damage the heater wires when the concrete is poured by workmen walking on the mesh.

TIPS:

Avoid using shovels and sharp objects when push concrete around. Use tools with dull ends or apply duct-tape to sharper tools to prevent damaging contact with the cable. Check the resistance regularly.

When walking around on the mesh, even if elevated with blocks, pull the mesh up by hand occasionally in completed sections. It will sink back to the block levels and it will prevent the cable and mesh to be unevenly layered into the slab.

9. Ensure the entire heating cable, joints or factory splices and thermostat conduit sensor are embedded in the concrete mortar.
10. Ensure the correct maturity and curing times for drying of construction materials is followed before you begin powering ON the heating cables. If unknown, plan for 30 days or curing time.
11. Once the concrete has cured enough for traffic, complete the electrical wiring. Apply conduits above and beyond the original PVC elements above in accordance with local electrical code.

IMPORTANT:

If the concrete slab is not the final flooring material, you may choose to install the sensor ON TOP OF the finished slab. This will give you more accurate readings in line with temperatures measured on the final floor covering. If doing so, simply lay the sensor on top of the slab either with tape or fixing strips and route to thermostat. Do not tape the sensing tip of the sensor.

12. Connection of the cold tail leads, sensor wire and mains supply must be conducted by a qualified electrician in accordance with the thermostat's instruction manual.

Finished Floor Surface Covering

Any surface finish (tile, laminate, wood, carpet, cork, vinyl etc.) can be applied over the finished concrete slab. However, care must be taken at all times that screws or nails used to attach floor coverings do not damage the heating cables. For wooden floors it is recommended that these be free floating floors and that the slab surface temperature does not exceed the allowable temperature stated by the wood flooring manufacturer.

Connect Thermostat and Testing

Instructions for fitting the Warmup® Thermostat can be found inside the thermostat box.

The thermostat's sensor probe can be installed a number of ways:

1. Placed directly in the top $\frac{3}{8}$ " (10mm) of the slab covering the heating wire.
2. Cemented into a channel cut out of the surface of the slab.

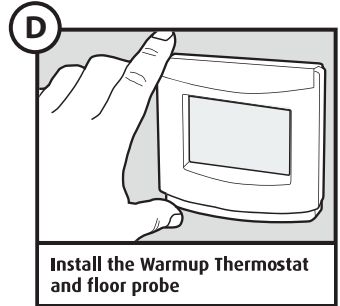

One final time, the heating cables should be tested and readings recorded, to ensure the resistance is correct for the cable supplied (plus or minus 5%). Visual inspection of the cable should also be carried out to ensure there is no physical damage. The testing should be carried out before the cable is laid and after cable has been installed to ensure no damage has occurred during installation. If these readings are incorrect, please call our helpline on 1-888-927-6333 for the US and Canada.

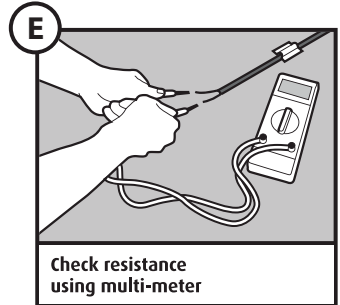

IMPORTANT

The heating cable must be kept a minimum of 2" (50mm) apart at all times.

The heating cable must not be cut, damaged or shortened.

The entire heating cable and joint must be laid under the floor slab.

Warmup 10-year Warranty

Models:

240Volt In-Slab Heaters (WODH) heaters sold by Warmup, Inc.

THE WARMUP 10 YEAR WARRANTY DOES NOT EXTEND TO THERMOSTATS, WHICH ARE COVERED BY A THREE-YEAR WARMUP WARRANTY FROM THE DATE OF ORIGINAL PURCHASE. GOVERNING LAW. Unless otherwise governed by applicable state law, this warranty shall be interpreted and enforced in accordance with the laws of the State of Connecticut.

This 10 Year Warranty applies:

1. Only to the original homeowner(s) from the date of purchase
2. Only if the unit is registered with Warmup within thirty (30) days after purchase. Filling out the online warranty in its entirety will complete registration. In the event of a claim, proof of purchase is required, i.e.: invoice and receipt. Such invoice and receipt should state the exact model that was purchased; and
3. Only for the duration of the Lifetime of the floor covering under which it was originally installed if the purchaser of the heater remains the owner of the residence in which it is installed.
4. Only if the heater is protected by a GROUND FAULT CIRCUIT INTERRUPTER (GFCI) at all times.

COVERAGE

- 1) The warranty period begins on the date of purchase. Registration is effective only when a letter of confirmation is sent by Warmup Inc.
- 2) Warmup's In-Slab heater is guaranteed by WARMUP INC. ("Warmup") to be free from defects in material and workmanship under normal use and maintenance for thirty (10) years, provided the product is installed in accordance with the accompanying Warmup installation manual, any special written design or installation guidelines by Warmup, Inc. for a particular project, the National Electrical Code (NEC) and all applicable local building and electrical codes; and
- 3) Provided Warmup heaters are installed under cement.
- 4) During the period of Warranty, Warmup will arrange for the heater to be repaired or (at its discretion) have parts replaced free of charge. The costs of repair or replacements are your only remedy under this Warranty. Such cost does not extend to any cost other than direct cost of repair or replacement by Warmup and does not extend to costs of relaying, replacing or repairing any floor covering or floor.
- 5) If Warmup, Inc. determines the repair of the product is not feasible; we will replace the product with equal or similar features and functionality at Warmup's sole discretion. (see "Exclusions").

EXCLUSIONS: Warmup, Inc. shall in no event be liable for incidental or consequential damages, including but not limited to extra utility expenses or damages to property. This Warranty is null and void if

- 1) The floor covering over the heater(s) is damaged, lifted, replaced, repaired or covered with subsequent layers of flooring.
- 2) The heater fails due to damage caused during installation or flooring installation, unless damage is caused directly by an employee of Warmup. It is therefore essential to check that the heater is working (as specified in the installation manual) prior to flooring installation.
- 3) Damage as a result of floods, fires, winds, lightning, accidents, corrosive atmosphere or other conditions beyond the control of Warmup, Inc.
- 4) Use of components or accessories not compatible with Warmup heaters
- 5) Warmup products installed outside North America.
- 6) Parts not supplied or designated by Warmup, Inc.
- 7) Damage or repair required as a result of any improper use, maintenance, operation or servicing.
- 8) Failure to start due to interruption and/or inadequate electrical service
- 9) Any damage caused by frozen or broken water pipes in the event of equipment failure.
- 10) Changes in the appearance of the product that does not affect its performance.
- 11) The owner, or his/her designated representative, attempts to repair the product without receiving prior authorization from Warmup. Upon notification of a repair problem, Warmup, Inc. will issue an Authorization to Proceed under the terms of this Warranty.

If Warmup is required to inspect or repair any defects caused by any exclusions referenced above, all work will be fully chargeable at Warmup's inspection and repair rates then in effect.

WARMUP, INC. DISCLAIMS ANY WARRANTY NOT PROVIDED HEREIN, INCLUDED ANY IMPLIED WARRANTY OF THE MERCHANTABILITY OR IMPLIED WARRANTY OF FITNESS FOR A PARTICULAR PURPOSE. WARMUP, INC. FURTHER DISCLAIMS ANY RESPONSIBILITY FOR SPECIAL, INDIRECT, SECONDARY, INCIDENTAL, OR CONSEQUENTIAL DAMAGES ARISING FROM OWNERSHIP OR USE OF THIS PRODUCT, INCLUDING INCONVENIENCE OR LOSS OF USE. THERE ARE NO WARRANTIES THAT EXTEND BEYOND THE FACE OF THIS DOCUMENT.

NO AGENT OR REPRESENTATIVE OF WARMUP, INC. HAS ANY AUTHORITY TO EXTEND OR MODIFY THIS WARRANTY UNLESS SUCH EXTENSION OR MODIFICATION IS MADE IN WRITING BY A CORPORATE OFFICER.

DUE TO DIFFERENCES IN BUILDING AND FLOOR INSULATION, CLIMATE AND FLOOR COVERINGS, WARMUP, INC. MAKES NO REPRESENTATION THAT THE FLOOR TEMPERATURE WILL ACHIEVE ANY PARTICULAR TEMPERATURE OR TEMPERATURE RISE.

CSA STANDARD LISTING REQUIREMENTS LIMIT THE HEAT OUTPUT OF WARMUP UNDER FLOOR HEATING, AS SUCH, USERS MAY OR MAY NOT BE SATISFIED WITH THE FLOOR WARMTH THAT IS PRODUCED. WARMUP DOES WARRANT THAT ALL HEATERS WILL PRODUCE THE RATED WATT OUTPUT LISTED ON THE HEATER NAMEPLATE, WHEN OPERATED AT THE RATED VOLTAGE.

TERMS AND CONDITIONS

Shipping Discrepancies:

Incoming materials should be inventoried for completeness and for possible shipping damage. Any visible damages or shortages must be noted prior to accepting the material. Any discrepancy concerning type or quantity of material shipped, must be brought to the attention of your Warmup® reseller within 15 days of the shipping date entered on the packing slip for the order.

Miscellaneous:

The terms of this Limited Warranty are exclusive and supercede any other warranty or terms and conditions relating to the subject matter whether included in a purchase order for this product or in any other document or statement.

NOTE: All spacings have been based on square areas for calculation purposes. Therefore actual spacing will vary according to the shape of the area to be heated. All spacings should be measured from the centre of the wire.

Warmup Inc USA

52 Federal Road | Unit 1F | Danbury | CT 06810 | T: 888-927-6333
F: 888-927-4721 | E: us@warmup.com | warmup.com

Warmup Inc Canada

374 Wellington St W | Toronto, ON M5V 1E3 | T: 888-592-7687
F: 905-366-7324 | E: ca@warmup.com | warmup.ca

In-slab heating cable sizing & spacing Guide

	Length (ft)	Code	Cable spaced at			Wattage (W)	Amps (A)	Resistance (Ω)
			3"	4"	5"			
			gives sq ft coverage of					
240 Volts	93	WODH-D-240V-18W/500	24	30	39	500	2.1	114.3
	176	WODH-D-240V-18W/950	44	59	74	950	4.0	60.0
	250	WODH-D-240V-18W/1300	62	84	104	1300	5.4	44.4
	315	WODH-D-240V-18W/1700	76	104	130	1700	7.1	33.8
	437	WODH-D-240V-18W/2400	105	146	182	2400	10.0	24.0
	625	WODH-D-240V-18W/3400	155	210	260	3400	14.2	16.9

Complete and submit the warranty form online at www.warmup.com (US) or www.warmup.ca (CA)

US Office

Warmup Inc
 52 Federal Road Unit 1F
 Danbury, CT 06810
 W: www.warmup.com
 E: us@warmup.com
 T: 1-888-927-6333
 F: 1-888-927-4721

Canadian Office

Warmup Inc
 374 Wellington St W
 Toronto, ON M5V 1E3
 W: www.warmup.ca
 E: ca@warmup.com
 T: 905-990-2075
 F: 905-366-7324